



ALING





NOVI PRISTUP IZRADE KUĆNIH INSTALACIJA
A NEW APPROACH OF HOME INSTALLATIONS



Od 1984. kvalitet i pouzdanost su glavni prioriteti u kompaniji Aling-Conel. To se podjednako odnosi na proizvode i usluge. Dugogodišnje iskustvo i brojna priznanja omogućila su nam da postanemo regionalni lider i pouzdan partner našim kupcima.

Since 1984, quality and reliability are the top priorities of the company Aling-Conel. This applies equally to products and services. Many years of experience and numerous awards have enabled us to become a regional leader and reliable partner to our customers.





ALING MODE je modularni pristup izradi kućnih električnih instalacija sa modularnim elektroinstalacionim komponentama za ugradnju u zid koje se mogu po želji naknadno menjati ili premeštati u postojećem sklopu ukoliko se raspored pokaže kao neadekvatan.

ALING MODE čine modularni elementi (sklopke, regulatori, priključnice), dekorativne maske i prirubnice. Modularni elementi izrađuju se u 2 boje: bela i antracit.

Široka lepeza boja dekorativnih maski omogućava uklapanje kako u tradicionalne, tako i u moderne enterijere.

ALING MODE is a modular approach in home electric installations. It consists of modular components that could be afterwards changed or moved in existing set.

ALING MODE consists of switches, dimmers, sockets, decorative frames and mounting frames.

Modules are done in two colors: white and anthracite.

Wide variety of colors in decorative frames allows usage in traditional and modern interiors.

MODERAN - POSTOJAN - MODULARAN - JEDNOSTAVAN
MODERN - STABLE - MODULAR - SIMPLE

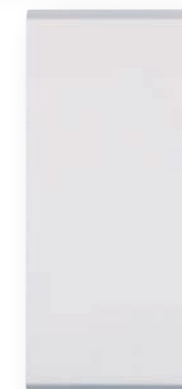

Bela
White
RAL 9003

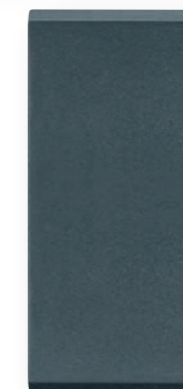

Antracit
Anthracite
RAL 7016

TEHNIČKE PREDNOSTI TECHNICAL ADVANTAGES

UNIVERZALNA INSTALACIJA

Ugradnja u montažne kutije Ø60 uz pomoć vijaka ili stegača. Mogućnost nizanja kutija. Program ALING MODE se na ovaj način može ugrađivati kod adaptacije postojećih instalacija bez ugradnje novih montažnih kutija.

UNIVERSAL INSTALLATION

Installation into the mounting box Ø60 with screws or screw clamps. The possibility of installation of mounting frames in row. Program ALING MODE in this way can be installed in adaptation of existing installations without installing of new prefabricated mounting boxes.

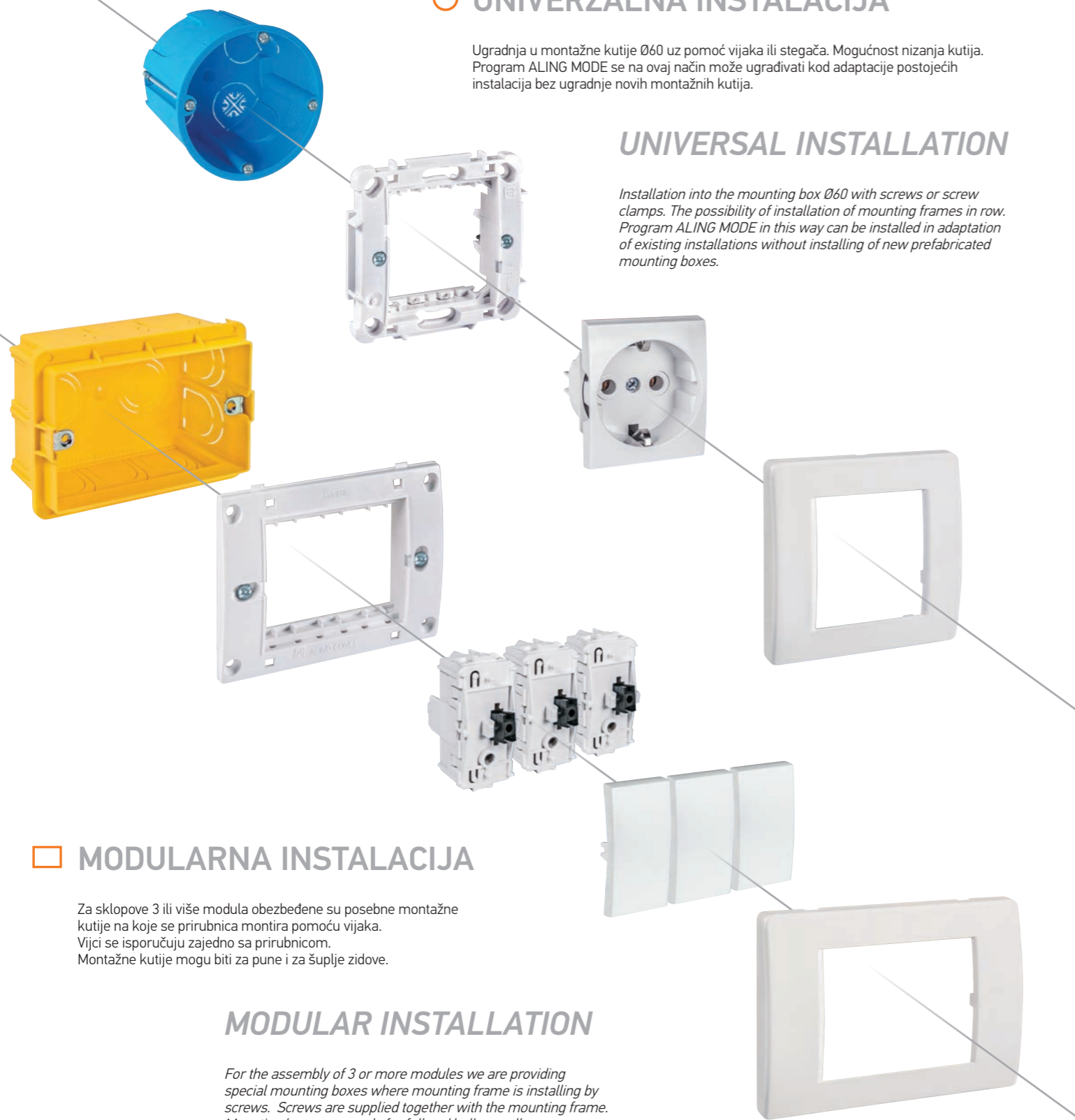

MODULARNA INSTALACIJA

Za sklopove 3 ili više modula obezbeđene su posebne montažne kutije na koje se prirubnica montira pomoću vijaka. Vijci se isporučuju zajedno sa prirubicom. Montažne kutije mogu biti za pune i za šuplje zidove.

MODULAR INSTALLATION

For the assembly of 3 or more modules we are providing special mounting boxes where mounting frame is installing by screws. Screws are supplied together with the mounting frame. Mounting boxes are made for full and hollow walls.

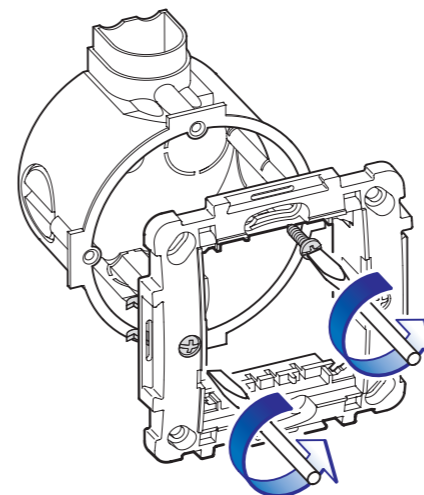

Kompatibilnost sa sistemom ugradnje u zid prema međunarodnim standardima obezbeđena je uvođenjem prirubnice koja nosi 1 ili 2 modula. Ova prirubnica se postavlja u standardnu montažnu kutiju Ø60 mm uobičajeno uz pomoć stegača ili vijaka.

Time je omogućeno da se program ALING MODE može ugrađivati kod adaptacije postojećih instalacija bez ugradnje novih montažnih kutija.

Compatibility with wall mounting system in accordance with international standards is enabled by mounting frame that has place for one or two modules. This mounting frame can be mounted in mounting box Ø60 mm by screws or clamps.

This makes it possible to use ALING MODE in renovation of existing installations without mounting new mounting boxes.

Za Sklopove za ugradnju 3 ili više modula obezbeđene su posebne montažne kutije na koje se prirubnica montira vijcima isporučenim zajedno sa prirubicom.

U zavisnosti od načina gradnje kutije se izrađuju za pune zidove:

For mounting three or more modules, special installation boxes are used. Mounting frame is mounting by screws that are supplied together with mounting frame.

Depending on method of building construction, mounting boxes are made for solid walls:

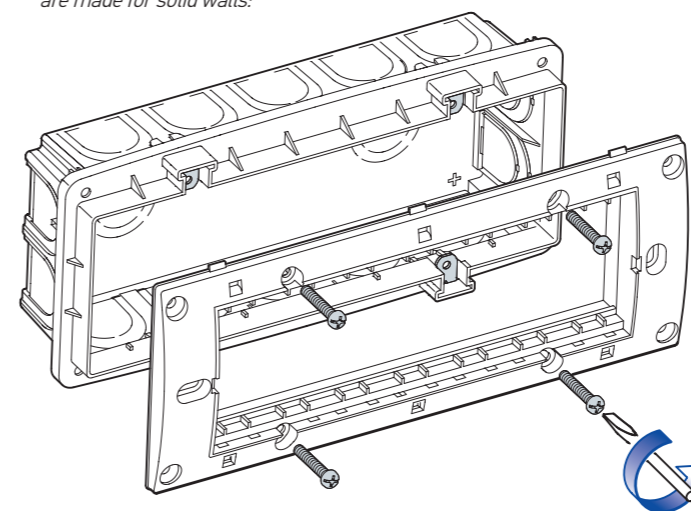

Dekoratívna maska se postavlja bez alata jednostavnim natiskivanjem na prirubnicu.

Skidanje maske je veoma jednostavno i izvodi se izvijačem na predviđenom mestu čime se smanjuje mogućnost oštećenja.

Decorative frame is placing without tools, by simple pressing onto the mounting frame.

Removing of decorative frame is simple and is done by screw driver on the provided point. This way possibility of damage is minored.

Ili za šuplje zidove (gipsane ploče, drvene ploče i slično):

or for hollow walls (gypsum boards, wooden boards):

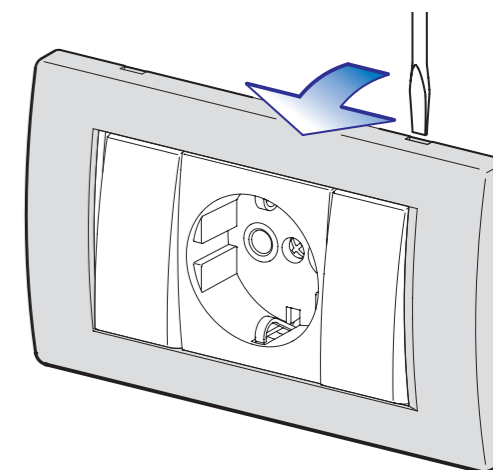
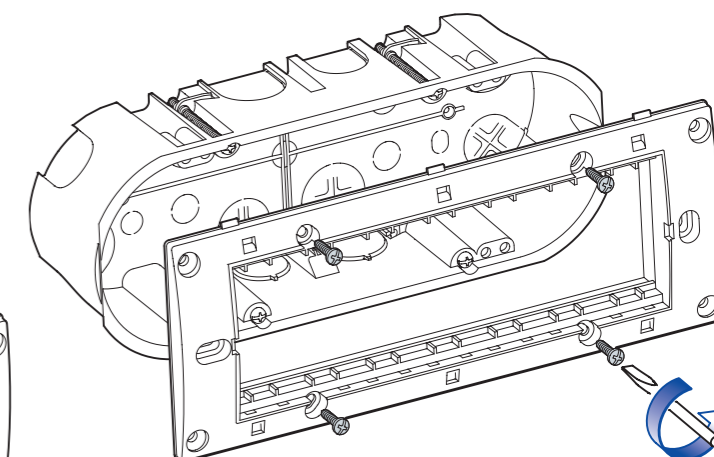

Postavljanje modula u noseću prirubnicu je veoma jednostavno ručnim utiskivanjem.

Sklop modula i noseće prirubnice izveden je tako da je skidanje svih modula moguće sa prednje strane bez skidanja prirubnice sa montažne kutije.

Dovoljno je skinuti taster ili blok priključnice i izvijačem otkačiti modul. Kod pojedinih proizvoda (regulatori, VF priključnice) skidanje modula se može obaviti bez uklanjanja bloka.

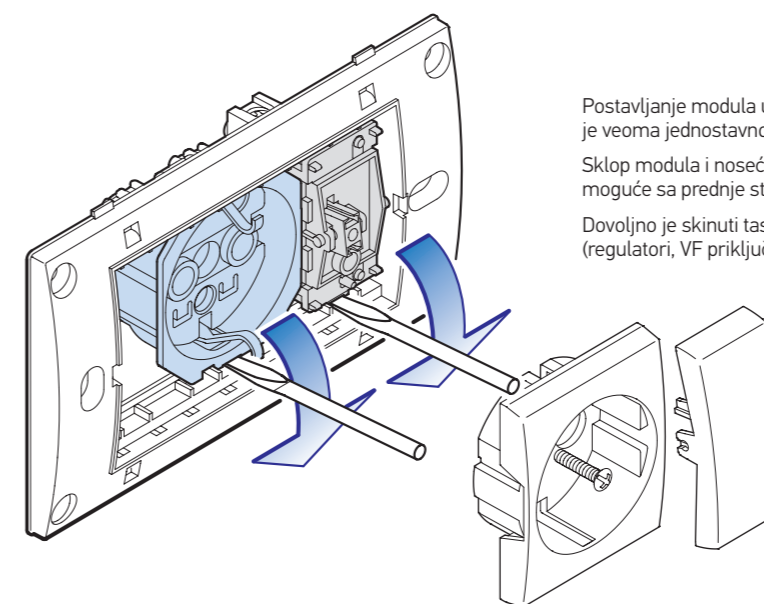

Placing the modules into the mounting frame is easy and simple, by hand pressing.

All modules are removing from the frontal side without removing mounting frame from mounting box.

First we remove button or socket block and then by screw driver simply unhook module. Some modules (dimmers, VF sockets) are unhooked without removing blocks.

SKLOPKE BEZ TASTERA SWITCHES WITHOUT BUTTON

Bela
White **x = 0**

Antracit
Anthracite **x = A**

- Usaglašeno sa IEC 60669-1
- Ugradnja u noseću prirubnicu utiskivanjem
- Complied with IEC 60669-1
- Installation into the mounting frame by pressing

SKLOPKE 10A SWITCHES 10A



6551
Sklopka jedнопolna
10AX 250V~ 1M
bez tastera
*1 pole switch
10AX 250V~ 1M
without button*



6851
Sklopka jedнопolna
16AX 250V~ 1M
bez tastera
*1 pole switch
16AX 250V~ 1M
without button*



6571
Sklopka naizmienična
10AX 250V~ 1M
bez tastera
*Alternative switch
10AX 250V~ 1M
without button*



6871
Sklopka naizmienična
16AX 250V~ 1M
bez tastera
*Alternative switch
16AX 250V~ 1M
without button*



6751
Sklopka jedнопolna
indikatorska
10AX 250V~ 1M
bez tastera
*1 pole switch
with indication
10AX 250V~ 1M
without button*



6691
Sklopka jedнопolna
indikatorska
16AX 250V~ 1M
bez tastera
*1 pole switch
with indication
16AX 250V~ 1M
without button*

- Indikacija svetli kada je sklopka uključena
- Indication turns on when the switch is on

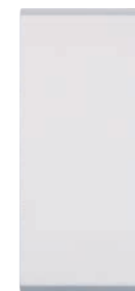

655.x
Sklopka jedнопolna
10AX 250V~ 1M
*1 pole switch
10AX 250V~ 1M*

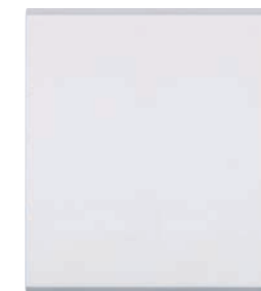

6552.x
Sklopka jedнопolna
10AX 250V~ 2M
*1 pole switch
10AX 250V~ 2M*

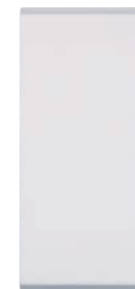

657.x
Sklopka naizmienična
10AX 250V~ 1M
*2 way switch
10AX 250V~ 1M*

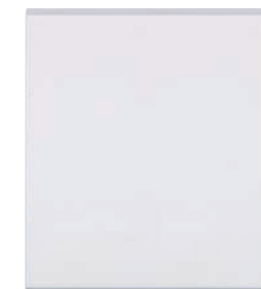

6572.x
Sklopka naizmienična
10AX 250V~ 2M
*2 way switch
10AX 250V~ 2M*

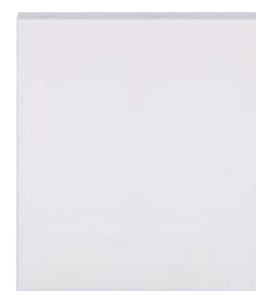

658.x
Sklopka ukrсна
10AX 250V~ 2M
*Intermediate
switch
10AX 250V~ 2M*

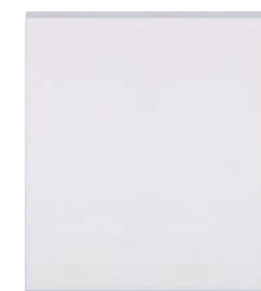

6554.x
Sklopka dvopolna
10AX 250V~ 2M
*2 pole switch
10AX 250V~ 2M*

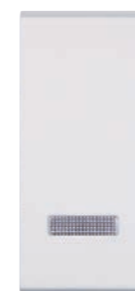

675.x
Sklopka jedнопolna
sa indikacijom
10AX 250V~ 1M
*1 pole switch
with indication
10AX 250V~ 1M*

- Indikacija svetli kada je sklopka isključena
- Indication turns on when the switch is off

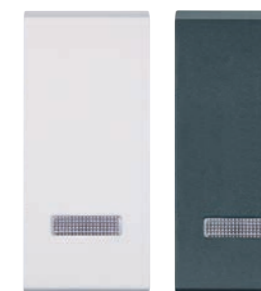

6752.x
Sklopka jedнопolna
indikatorska
10AX 250V~ 1M
*1 pole switch
with indication
10AX 250V~ 1M*

- Indikacija svetli kada je sklopka uključena
- Indication turns on when the switch is on



677.x
Sklopka naizmienična
sa indikacijom
10AX 250V~ 1M
*2 way switch
with indication
10AX 250V~ 1M*

- Indikacija svetli kada je strujno kolo otvoreno
- Indication turns on when the circuit is open

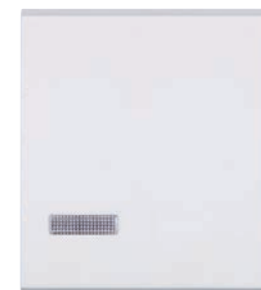

678.x
Sklopka ukrсна
sa indikacijom
10AX 250V~, 2M
*Intermediate
switch
with indication
10AX 250V~, 2M*

- Indikacija svetli kada je strujno kolo otvoreno
- Indication turns on when the circuit is open

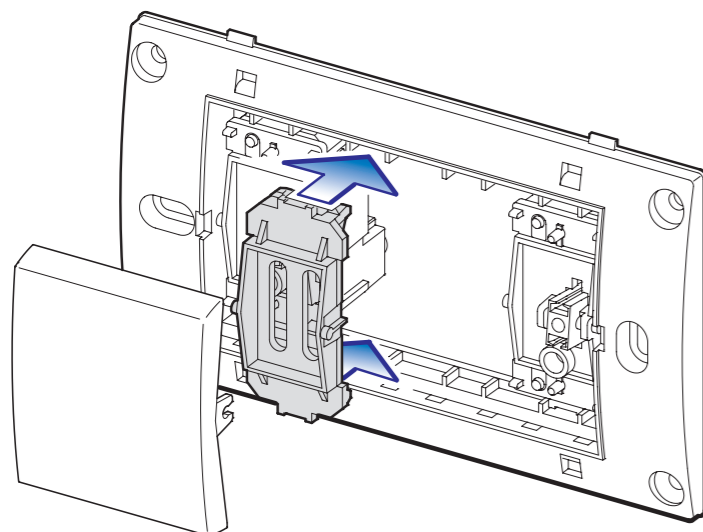

Dupli tasteri se mogu postavljati na sklopke širine modula 22,2 mm uz korišćenje posebnog nosača koji se isporučuje uz taster. Nosač se u prirubnicu postavi pored sklopke, a taster na sklopku i nosač zajedno.

Kod tastera sa indikacijom voditi računa o položaju sklopke i nosača tako da otvor za indikaciju dođe iznad tinjalice na sklopki.

2M switch buttons are placed on 1M switches, by using a special holder supplied with 2M button. Holder is placing next to the switch and then we place 2M button on switch and holder at the same time.

For push buttons with indication it is necessary to pay attention on position of switch and holder, so the hole for indication must be placed above indicating light.



689.x

Taster sklopka
jednopolna
10AX 250V- 1M

1 pole
push-button
switch
10AX 250V- 1M

Bela
White **x = 0**

Antracit
Anthracite **x = A**

ALING **MO**
DE

SKLOPKE 16A SWITCHES 16A



- Usaglašeno sa IEC 60669-1
- Ugradnja u noseću prirubnicu utiskivanjem
- Complied with IEC 60669-1
- Installation into the mounting frame by pressing

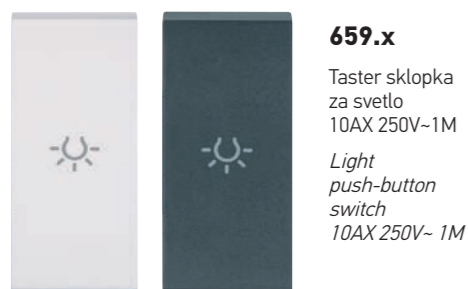

659.x

Taster sklopka
za svetlo
10AX 250V-1M

Light
push-button
switch
10AX 250V- 1M

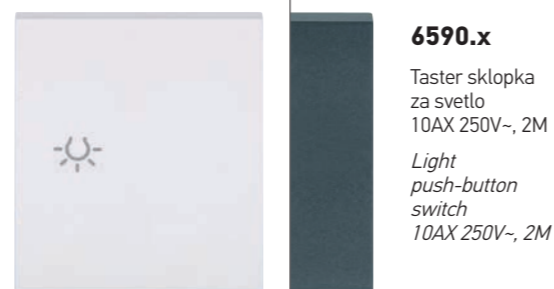

6590.x

Taster sklopka
za svetlo
10AX 250V-, 2M

Light
push-button
switch
10AX 250V-, 2M



685.x

Sklopka
jednopolna
16AX 250V- 1M

1 pole switch
16AX 250V- 1M



669.x

Sklopka
jednopolna
sa indikacijom
16AX 250V- 1M

1 pole switch
with indication
16AX 250V- 1M

- Indikacija svetli
kada je sklopka
isključena
- Indication turns
on when the
switch is off



6591.x

Taster sklopka
za svetlo
sa indikacijom
10AX 250V- 1M

Light
push-button
switch
with indication
10AX 250V- 1M

- Indikacija svetli
kada je sklopka
isključena
- Indication turns
on when the
switch is off

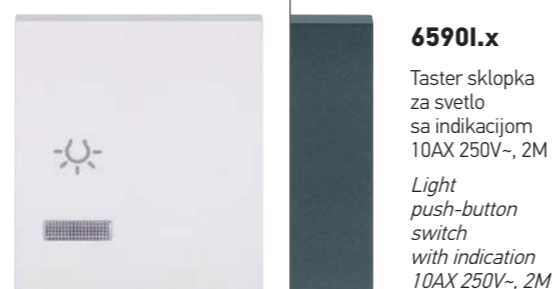

65901.x

Taster sklopka
za svetlo
sa indikacijom
10AX 250V-, 2M

Light
push-button
switch
with indication
10AX 250V-, 2M

- Indikacija svetli
kada je sklopka
isključena
- Indication turns
on when the
switch is off



687.x

Sklopka
naizmjenična
16AX 250V- 1M

2 way switch
16AX 250V- 1M



6692.x

Sklopka
jednopolna
indikatorska
16AX 250V- 1M

1 pole witch
with indication
16AX 250V- 1M

- Indikacija svetli
kada je sklopka
uključena
- Indication turns
on when the
switch is on

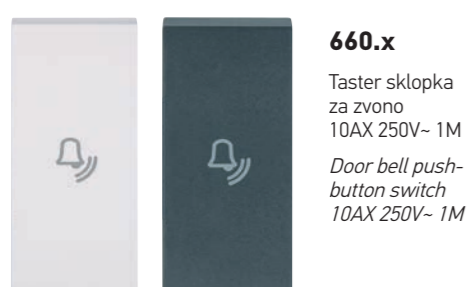

660.x

Taster sklopka
za zvono
10AX 250V- 1M

Door bell push-
button switch
10AX 250V- 1M

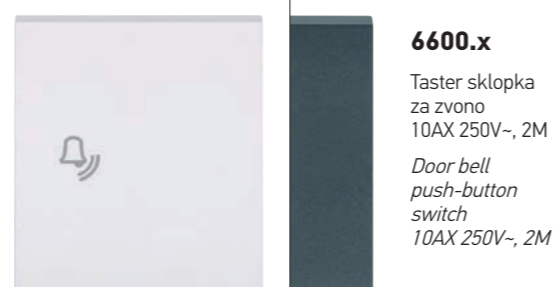

6600.x

Taster sklopka
za zvono
10AX 250V-, 2M

Door bell
push-button
switch
10AX 250V-, 2M

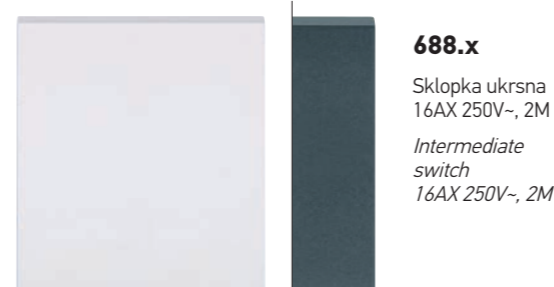

688.x

Sklopka ukrsna
16AX 250V-, 2M

Intermediate
switch
16AX 250V-, 2M



670.x

Sklopka
naizmjenična
sa indikacijom
16AX 250V- 1M

2 way switch
with indication
16AX 250V- 1M

- Indikacija svetli
kada je strujno
kolo otvoreno
- Indication turns
on when the
circuit is open

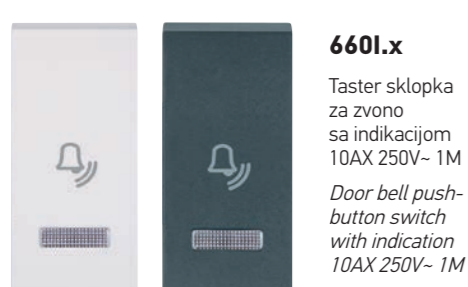

6601.x

Taster sklopka
za zvono
sa indikacijom
10AX 250V- 1M

Door bell push-
button switch
with indication
10AX 250V- 1M

- Indikacija svetli
kada je sklopka
isključena
- Indication turns
on when the
switch is off

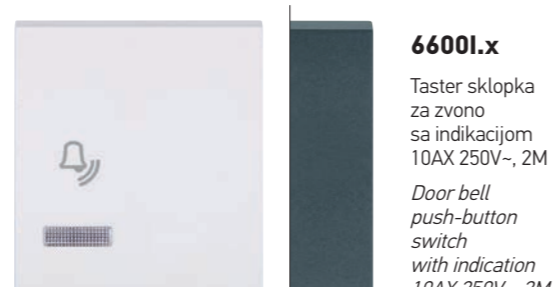

66001.x

Taster sklopka
za zvono
sa indikacijom
10AX 250V-, 2M

Door bell
push-button
switch
with indication
10AX 250V-, 2M

- Indikacija svetli
kada je sklopka
isključena
- Indication turns
on when the
switch is off



671.x

Sklopka ukrsna
sa indikacijom
16AX 250V-, 2M

Intermediate
switch
with indication
16AX 250V-, 2M

- Indikacija svetli
kada je strujno
kolo otvoreno
- Indication turns
on when the
circuit is open



690.x

Taster sklopka
za roletne
10AX 250V-, 2M

Push-button
shutters switch
10AX 250V-, 2M

- Par taster sklopki povezanih
za upravljanje kretanjem
elektromotora za roletne
u dva smera
- A pair of connected push-button
switches for the control of shutters
electric motor movement
in two directions

TASTERI SWITCH BUTTONS

Bela
White **x = 0**
 Antracit
Anthracite **x = A**

- Ugradnja na sklopku utiskivanjem
- Installation onto the switch by pressing



6541.x
Taster 1M za sklopke bez indikacije
Button 1M for switches without indication

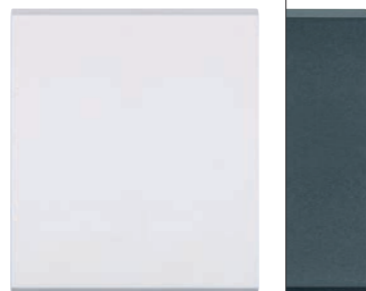

6581.x
Taster 2M za sklopke bez indikacije
Button 2M for switches without indication

1M	65411.x	65412.x	65413.x	65414.x	65415.x	65416.x
2M	65811.x	65812.x	65813.x	65814.x	65815.x	65816.x
sa oznakom <i>with symbol</i>	strelica gore <i>arrow up</i>	strelica dole <i>arrow down</i>	pojačavanja <i>amplification</i>	ključa <i>key</i>	0-I <i>0-I</i>	posluge <i>servants</i>



6542.x
Taster 1M za sklopke sa indikacijom
Button 1M for switches with indication

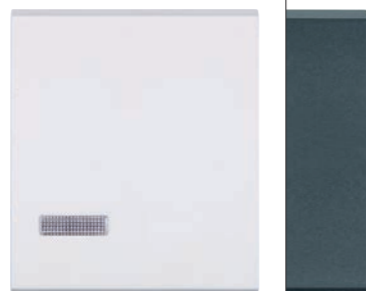

6582.x
Taster 2M za sklopke sa indikacijom
Button 2M for switches with indication

1M	65421.x	65422.x	65423.x	65424.x	65425.x	65426.x	65427.x	65428.x
2M	65821.x	65822.x	65823.x	65824.x	65825.x	65826.x	65827.x	65828.x
sa oznakom <i>with symbol</i>	svetla <i>light</i>	zvona <i>bell</i>	bojlera <i>boiler</i>	grejalice <i>heater</i>	ventilatora <i>fan</i>	priključnice <i>socket</i>	veš mašine <i>washing machine</i>	tuša <i>shower</i>



6500.x
Poklopac maske 1M (slepi modul)
Blank module 1M

- Za pokrivanje mesta gde nedostaje modul
- Pokriva širinu jednog modula 22,2mm
- Ugradnja u noseću prirubnicu utiskivanjem
- For covering the places where module is missing
- Covers the width of one module 22,2mm
- Installation into the holding frame by pressing

ELEKTRONIKA ELECTRONICS

- Za sijalice sa užarenim vlaknom i halogene sijalice sa standardnim transformatorom 230V- 40-300W;
- Za halogene sijalice sa standardnim transformatorom 40-300VA;
- Usaglašeno sa IEC 60669-2-1;
- Ugradnja u noseću prirubnicu utiskivanjem;
- Indikacija

- For the incandescent lamps and halogen lamps with standard transformer 230V- 40-300W;
- For halogen lamps with standard transformer 40-300VA;
- Complied with IEC 60669-2-1;
- Installation into the mounting frame by pressing;
- Indication



667.x
Elektronski regulator 40-300VA 1M
Dimmer rotative 40-300VA 1M



6671.x
Elektronski regulator sa naizmeničnom sklopkom 40-300VA 1M
Dimmer with alternative switch 40-300VA 1M



6672.x
Elektronski regulator za induktivno opterećenje, 40-300VA 1M
Dimmer for inductive load, 40-300VA 1M

- Za sijalice sa užarenim vlaknom i halogene sijalice 230V- 40-500W;
- Za halogene sijalice sa standardnim transformatorom 40-300VA;
- Za halogene sijalice sa elektronskim transformatorom 40-200VA;
- Usaglašeno sa IEC 60669-2-1;
- Ugradnja u noseću prirubnicu utiskivanjem;
- Indikacija uključenosti
- For the incandescent lamps and halogen lamps 230V- 40-500W;
- For halogen lamps with standard transformer 40-300VA;
- For halogen lamps with electronic transformer 40-200VA;
- Complied with IEC 60669-2-1;
- Installation into the mounting frame by pressing;
- Indication when dimmer is ON



6681.x
Elektronski regulator sa rotacionom sklopkom, 800W 1M
Dimmer with rotary switch, 800W 1M

- Za sijalice sa užarenim vlaknom i halogene sijalice 230V- 40-800W;
- Za halogene sijalice sa standardnim transformatorom 40-400VA;
- Usaglašeno sa IEC 60669-2-1;
- Ugradnja u noseću prirubnicu utiskivanjem;
- Indikacija uključenosti
- For the incandescent lamps and halogen lamps 230V- 40-800W;
- For halogen lamps with standard transformer 40-400VA;
- Complied with IEC 60669-2-1;
- Installation into the mounting frame by pressing;
- Indication when dimmer is ON

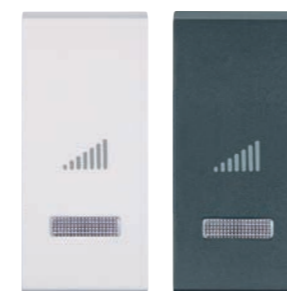

6674.x
Elektronski regulator za LED 200W 1M
Dimmer for LED 200W 1M

- Univerzalni taster elektronski regulator za sve vrste sijalica;
- Osnovna namena za CFL i LED dimabilne sijalice do 200W;
- Usaglašeno sa IEC 60669-2-1;
- Ugradnja u noseću prirubnicu utiskivanjem;
- Indikacija
- Universal push-button dimmer for all types of bulbs;
- The main purpose for dimmable CFL and LED bulbs up to 200W;
- Complied with IEC 60669-2-1;
- Installation into the mounting frame by pressing;
- Indication



6673.x
Infracrveni detektor pokreta 500W, 230V~/50Hz 2M
Infrared motion detector 500W, 230V~/50Hz 2M

- Relejni izlaz max 500W za sve tipove sijalica;
- Regulacija vremena isključenosti 10 s - 10 min;
- Regulacija osvetljenosti pri kojoj senzor reaguje 2 - 2000 lx;
- Regulacija svetlosti;
- Mogućnost aktiviranja spoljnim tasterom;
- Vidni ugao po horizontali 110°;
- Usaglašeno sa IEC 60669-2-1;
- Ugradnja u noseću prirubnicu utiskivanjem;
- Indikacija
- Relay exit max 500W for all lamps;
- Time regulation 10 s - 10 min;
- Light threshold regulation 2 - 2000 lx;
- Sensitivity lever regulation;
- External push button activation;
- Horizontal view angle 110°;
- Complied with IEC 60669-2-1;
- Installation into the mounting frame by pressing;
- Indication

SKLOPKE ZA KUPATILO BATHROOM SWITCHES



66911.00

Set sklopki za kupatilo 10A/2x16A 250V~ sa indikatorom i kutijom 3M, horizontalno (svetlo, grejalica, boiler)

Bathroom switch set 10A/2x16A 250V~ with indicator and mounting box 3M horizontal (light, heater, boiler)

- Usaglašeno sa IEC 60669-1;
- Ugradnja u montažnu kutiju pomoću vijaka
- Complied with IEC 60669-1;
- Installation into the mounting box by screws



66913.00

Set sklopki za kupatilo 2x10A/2x16A 250V~ sa indikatorom i kutijom 4M, horizontalno (svetlo, ventilator, grejalica, boiler)

Bathroom switch set 2x10A/2x16A 250V~ with indicator and mounting box 4M horizontal (light, fan, heater, boiler)

- Usaglašeno sa IEC 60669-1;
- Ugradnja u montažnu kutiju pomoću vijaka
- Complied with IEC 60669-1;
- Installation into the mounting box by screws



66915.00

Set sklopki za kupatilo 2x10A/2x16A 250V~ sa indikatorom i kutijom 5M, horizontalno (svetlo 2M, ventilator, grejalica, boiler)

Bathroom switch set 2x10A/2x16A 250V~ with indicator and mounting box 5M horizontal (light 2M, fan, heater, boiler)

- Usaglašeno sa IEC 60669-1;
- Ugradnja u montažnu kutiju pomoću vijaka
- Complied with IEC 60669-1;
- Installation into the mounting box by screws



66912.00

Set sklopki za kupatilo 10A/2x16A 250V~ sa indikatorom i kutijom 2x2M, vertikalno (svetlo 2M, grejalica, boiler) EXP

Bathroom switch set 10A/2x16A 250V~ with indicator and mounting box 2x2M vertical (light 2M, heater, boiler) EXP

- Usaglašeno sa IEC 60669-1;
- Ugradnja u dve vertikalne nizajuće kutije Ø60 pomoću vijaka
- Complied with IEC 60669-1;
- Installation into two vertical mounted boxes Ø60 by screws



66914.00

Set sklopki za kupatilo 2x10A/2x16A 250V~ sa indikatorom i kutijom 2x2M, vertikalno (svetlo, ventilator, grejalica, boiler) EXP

Bathroom switch set 2x10A/2x16A 250V~ with indicator and mounting box 2x2M vertical (light, fan, heater, boiler) EXP

- Usaglašeno sa IEC 60669-1;
- Ugradnja u dve vertikalne nizajuće kutije Ø60 pomoću vijaka
- Complied with IEC 60669-1;
- Installation into two vertical mounted boxes Ø60 by screws

PRIKLJUČNICE
SOCKET OUTLETS



651.x

Priključnica dvopolna
16A 250V~ 2M
*2 pole socket outlet
16A 250V~ 2M*

- Usaglašeno sa IEC 60884-1
- Ugradnja u noseću prirubnicu utiskivanjem
- *Complied with IEC 60884-1*
- *Installation into the mounting frame by pressing*

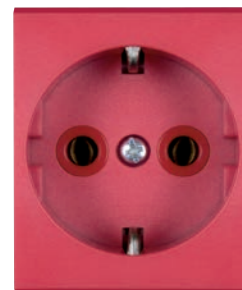

651.4

crveni blok
red block

- Za mreže sa UPS (sa transformatorom)
- *For power networks with UPS (with transformer)*



651.12

zeleni blok
green block

- Za mreže sa zaštićenim generatorskim napajanjem
- *For power networks with protected generator supply via transformer*



651.N

narandžasti blok
orange block

- Za mreže sa generatorskim napajanjem preko transformatora
- *For power networks with generator supply via transformer*



653.xx

Priključnica dvopolna sa poklopcem
16A 250V~ 2M
*2 pole socket outlet with cover
16A 250V~ 2M*

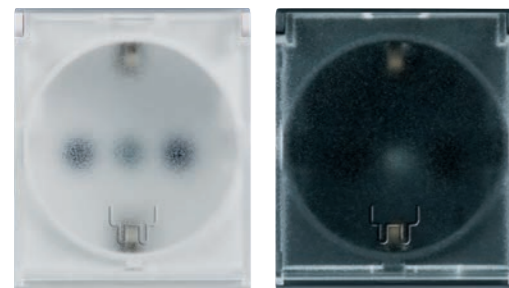

653.xT

Priključnica dvopolna sa transparentnim poklopcem
16A 250V~ 2M
*2 pole socket outlet with transparent cover
16A 250V~ 2M*

PRIKLJUČNICE
SOCKET OUTLETS



- Bela
White **x = 0**
- Antracit
Anthracite **x = A**



66512.x

Sklop dve priključnice dvopolne
16A 250V ~ 2x2M premoštene
*Sokets set
16A 250V~
2x2M
bridged*



66513.x

Sklop tri priključnice dvopolne
16A 250V ~ 3x2M premoštene
*Sokets set
16A 250V~
3x2M
bridged*

Premošćeni sklopovi priključnica.
Dovoljno je samo priključiti napojni kabal.

*Socket outlet assembly with bridged contact.
One need only connect the cable.*

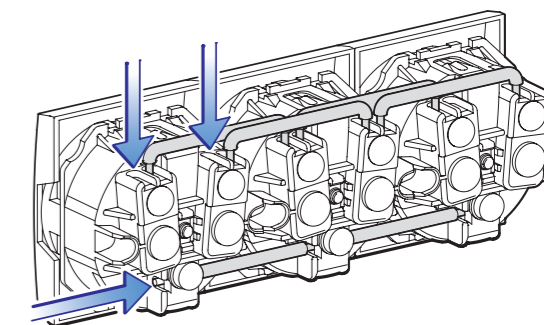
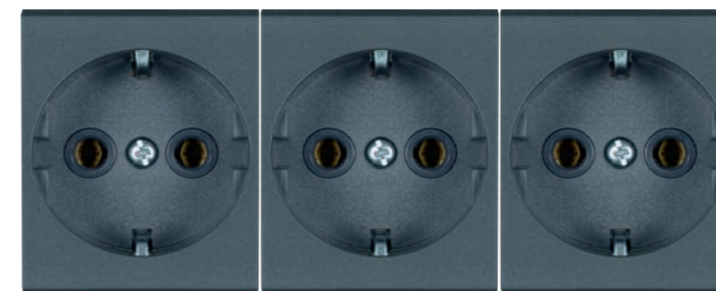

652.x

Priključnica dvopolna CEI 23-50/P11 italijanska
10A 250V~ 1M
*2 pole socket outlet CEI 23-50/P11 italian type,
10A 250V~ 1M*

- Usaglašeno sa CEI 23-50/P11;
- Ugradnja u noseću prirubnicu utiskivanjem

- *Complied with CEI 23-50/P11;*
- *Installation into the mounting frame by pressing*



652.4

Priključnica dvopolna CEI 23-50/P11 italijanska, crvena
10A 250V~ 1M
*2 pole socket outlet CEI 23-50/P11 italian type, red
10A 250V~ 1M*

- Za mreže sa UPS (sa transformatorom)
- *For power networks with UPS (with transformer)*



-  Bela
White **x = 0**
-  Antracit
Anthracite **x = A**



654.x

Priključnica dvopolna
16A 250V~ 2M
Francuski standard

*2 pole socket outlet
16A 250V~ 2M
French standard*

- Usaglašeno sa IEC 60884-1
- Ugradnja u noseću prirubnicu utiskivanjem
- *Complied with IEC 60884-1*
- *Installation into the mounting frame by pressing*



6629.x

Priključnica USB
punjač MODE
2,1A 5V~1M

*Power supply unit
USB MODE
2,1A 5V- 1M*

- Za punjenje elektronskih uređaja putem standardnog USB porta
- Usaglašeno sa EN 60950-1 i EMC direktivom
- Ugradnja u noseću prirubnicu utiskivanjem
- *For charging of electronic devises via standard USB port*
- *Complied with EN 60950-1 and EMC directive*
- *Installation into the mounting frame by pressing*



654.4

crveni blok
red block

- Za mreže sa UPS (sa transformatorom)
- *For power networks with UPS (with transformer)*



654.12

zeleni blok
green block

- Za mreže sa zaštićenim generatorskim napajanjem
- *For power networks with protected generator supply via transformer*

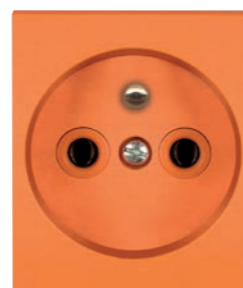

654.N

narandžasti blok
orange block

- Za mreže sa generatorskim napajanjem preko transformatora
- *For power networks with generator supply via transformer*



661.x

Priključnica telefonska
RJ12 6/2 1M

*Telephone socket
RJ12 6/2 1M*

- Usaglašeno sa IEC 60603-7;
- Priključak za jednu paricu (linija)
- Ugradnja u noseću prirubnicu utiskivanjem
- *Complied with IEC 60603-7;*
- *Connection for one pair (line);*
- *Installation into the mounting frame by pressing*



6540.x

Priključnica dvopolna sa zaštitom od dodira
16A 250V~ 2M
Francuski standard

*2 pole socket outlet with safety shutter
16A 250V~ 2M
French standard*

- Usaglašeno sa IEC 60884-1
- Ugradnja u noseću prirubnicu utiskivanjem
- *Complied with IEC 60884-1*
- *Installation into the mounting frame by pressing*



663.x

Priključnica telefonska
RJ12 6/4 1M

*Telephone socket
RJ12 6/4 1M*

- Usaglašeno sa IEC 60603-7;
- Priključak za dve parice (linija + terminal);
- Ugradnja u noseću prirubnicu utiskivanjem
- *Complied with IEC 60603-7;*
- *Connection for two pairs (line+terminal);*
- *Installation into the mounting frame by pressing*

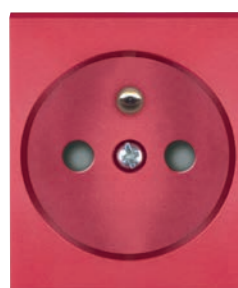

6540.4

crveni blok
red block

- Za mreže sa UPS (sa transformatorom)
- *For power networks with UPS (with transformer)*



6540.12

zeleni blok
green block

- Za mreže sa zaštićenim generatorskim napajanjem
- *For power networks with protected generator supply via transformer*

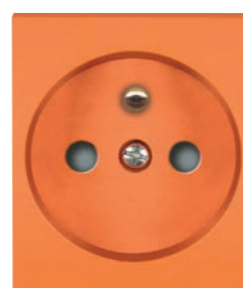

6540.N

narandžasti blok
orange block

- Za mreže sa generatorskim napajanjem preko transformatora
- *For power networks with generator supply via transformer*



6631.x

Priključnica telefonska
Keystone
RJ12 6/6 Cat 3 1M

*Telephone socket
Keystone
RJ12 6/6 Cat 3 1M*

- Usaglašeno sa IEC 60603-7;
- Za ISDN linije;
- Montaža provodnika bez upotrebe alata (Toolless)
- Ugradnja u noseću prirubnicu utiskivanjem
- *Complied with IEC 60603-7;*
- *For ISDN lines;*
- *Toolless conducting wire installation;*
- *Installation into the mounting frame by pressing*

	Bela White	x = 0
	Antracit Anthracite	x = A



664.x

Priključnica komunikacijska, Keystone RJ45 Cat 5e UTP 1M

Data socket
Keystone RJ45
Cat 5e UTP 1M



664S.x

Priključnica komunikacijska, Keystone RJ45 Cat 5e FTP 1M

Data socket
Keystone RJ45
Cat 5e FTP 1M

- Usaglašeno sa IEC 60603-7;
- Montaža provodnika bez upotrebe alata (Toolless);
- Spajanje prema TIA/EIA-568A ili 568B standardu za raspored parica;
- Ugradnja u noseću pribornicu utiskivanjem

- Complied with IEC 60603-7;
- Toolless conducting wire installation;
- Connecting according to TIA/EIA-568A or 568B standard for the arrangement of pairs;
- Installation into the mounting frame by pressing



665.x

Priključnica komunikacijska, Keystone RJ45 Cat 6 UTP 1M

Data socket
Keystone RJ45
Cat 6 UTP 1M



665S.x

Priključnica komunikacijska, Keystone RJ45 Cat 6 FTP 1M

Data socket
Keystone RJ45
Cat 6 FTP 1M



666.x

Priključnica komunikacijska, ELine RJ45 Cat 6 UTP 1M

Data socket
ELine RJ45
Cat 6 UTP 1M



666S.x

Priključnica komunikacijska, ELine RJ45 Cat 6 STP 1M

Data socket
ELine RJ45
Cat 6 STP 1M



666M.x

Priključnica komunikacijska, ELine EC7 Cat 7 STP 1M

Data socket
ELine EC7
Cat 7 STP 1M

- Mogućnost korišćenja za multimedijalne komunikacije;
- Montaža provodnika bez upotrebe alata (Toolless);
- Ugradnja u noseću pribornicu utiskivanjem

- Multimedia communication use;
- Toolless conducting wire installation;
- Installation into the mounting frame by pressing

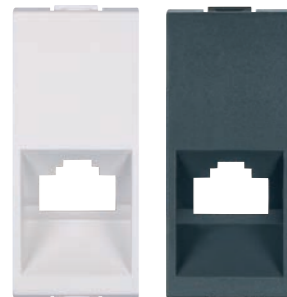

6519.x

Keystone nosač 1M

Keystone holder 1M

- Modul širine 22,2mm za nošenje Keystone konektora
- Ugradnja u noseću pribornicu utiskivanjem

- Module 22,2mm width for Keystone connectors holding
- Installation into the mounting frame by pressing



6621.x

Priključnica antenska TV IEC M /F za individualne sisteme 1M

TV aerial socket
IEC M/F,
for individual
systems 1M

- Usaglašeno sa IEC 169-2 - muški konektor;
- Montaža antenskog kabla preko F konektora;
- Bez prigušenja signala;
- Ugradnja u noseću pribornicu utiskivanjem

- Complied with IEC 169-2 - M connector;
- Installation of aerial cable by F connector;
- Without signal attenuation; 1
- Installation into the mounting frame by pressing



6622.x

Priključnica antenska FM, IEC F /F 1M

FM aerial
socket,
IEC F/F 1M

- Usaglašeno sa IEC 169-2 - ženski konektor;
- Montaža antenskog kabla preko F konektora;
- Bez prigušenja signala;
- Ugradnja u noseću pribornicu utiskivanjem

- Complied with IEC 169-2 - F connector;
- Installation of aerial cable by F connector;
- Without signal attenuation; 1
- Installation into the mounting frame by pressing



6623.x

Priključnica antenska TV, IEC završna 5dB 1M

TV aerial socket
end-line
5db IEC 1M

- Usaglašeno sa IEC 169-2 - muški konektor;
- Montaža antenskog kabla preko vijčane veze;
- Prigušenje signala cca 5dB;
- Ugradnja u noseću pribornicu utiskivanjem

- Complied with IEC 169-2 - M connector;
- Installation of aerial cable by screw terminals;
- Signal attenuation approx. 5dB;
- Installation into the mounting frame by pressing



6624.x

Priključnica antenska TV, prolazna 10dB IEC 1M

TV aerial socket
throughpass,
10db IEC 1M

- Usaglašeno sa IEC 169-2 - muški konektor;
- Montaža antenskog kabla preko vijčane veze;
- Prigušenje signala cca 10dB;
- Ugradnja u noseću pribornicu utiskivanjem

- Complied with IEC 169-2 - M connector;
- Installation of aerial cable by screw terminals;
- Signal attenuation approx. 10dB;
- Installation into the mounting frame by pressing



6625.x

Priključnica antenska TV F/F, za individualne sisteme SAT 1M

TV aerial
socket, F/F
for individual
systems 1M

- Završna za satelitske antene;
- Montaža antenskog kabla preko F konektora;
- Bez prigušenja signala;
- Ugradnja u noseću pribornicu utiskivanjem

- Terminal for satellite aerials;
- Installation of aerial cable by F connector;
- Without signal attenuation;
- Installation into the mounting frame by pressing



6627.x

Priključnica audio 2xRCA 1M

Audio socket
2XRCA 1M

- Za prenos audio signala - stereo;
- Montaža provodnika lemljenjem;
- Ugradnja u noseću pribornicu utiskivanjem

- For the transmission of audio signals stereo;
- Installation of conducting wires by soldering;
- Installation into the mounting frame by pressing



6628.x

Priključnica audio/video BNC/BNC 1M

Audio/video
socket,
BNC/BNC 1M

- Za prenos audio ili video signala;
- Montaža kabla preko BNC konektora;
- Ugradnja u noseću pribornicu utiskivanjem

- For the transmission of audio or video signals;
- Installation of cable by BNC connector;
- Installation into the mounting frame by pressing

TERMOPLASTIČNE MASKE
THERMOPLASTIC DECORATIVE FRAMES

TERMOPLASTIČNE MASKE
sastoje se od 4 boje:
bela, grafit, bordo i krem.

*THERMOPLASTIC
DECORATIVE FRAMES
are consists of 4 colors: white,
graphite, dark red and beige.*

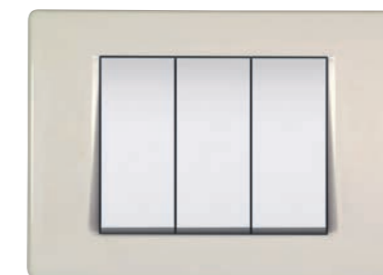
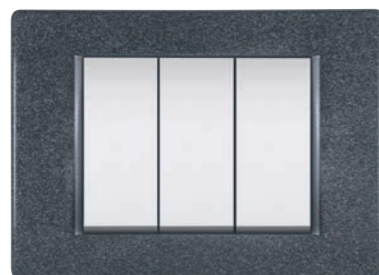
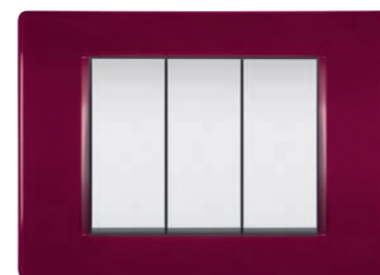
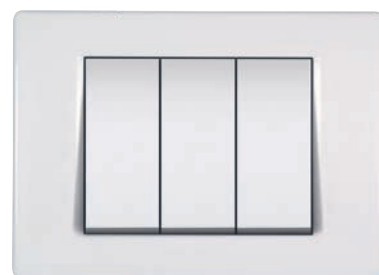

METALIZIRANE MASKE
METALLIC DECORATIVE FRAMES

METALIZIRANE MASKE sastoje se od 5 metalik boja: zlatna, srebrna, metalik plava, bakarna i metalik zelena.

METALLIC DECORATIVE FRAMES consists of 5 metallic colors: gold, silver, metallic blue, cooper and metallic green.

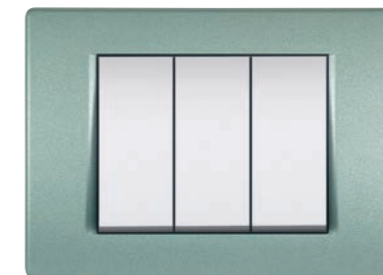
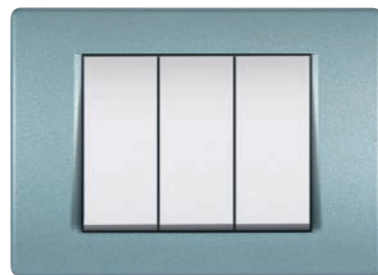
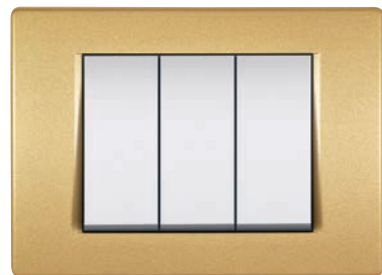

DRVENE MASKE
WOODEN DECORATIVE FRAMES

DRVENE MASKE čine pet elegantnih maski od drveta: mahagoni, hrast, orah, jasen i wenge

WOODEN FRAMES are made of natural wood and consists of five elegant cover frames: mahogany, oak, nut, ash, wenge



TERMOPLASTIČNE
MASKE
THERMOPLASTIC
DECORATIVE
FRAMES

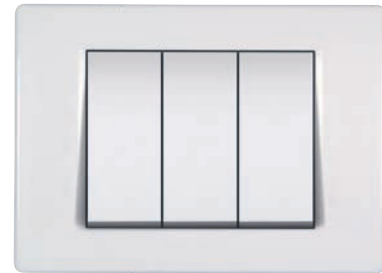

x = 0 Bela / White



x = 2 Grafit / Graphite

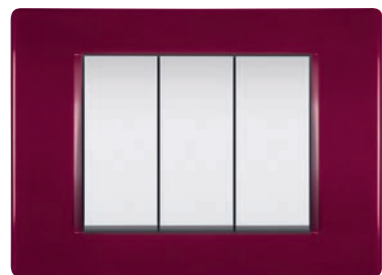
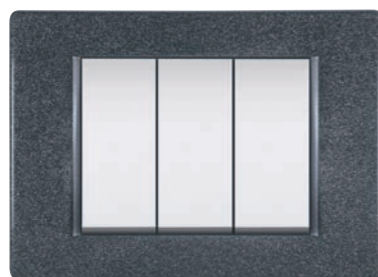

x = 3 Bordo / Dark red



x = 9 Krem / Beige

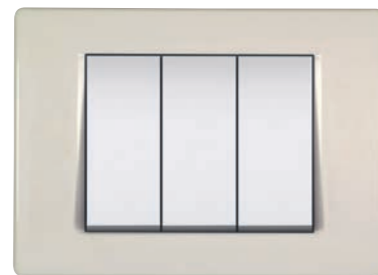

METALIZIRANE
MASKE
METALLIC
DECORATIVE
FRAMES



x = G Zlatna / Gold



x = S Srebrna / Silver

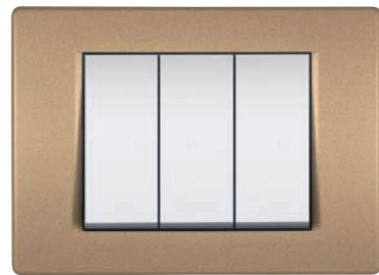
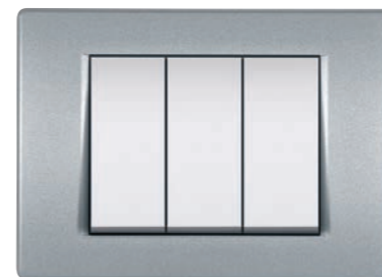

x = C Bakarna / Cooper



x = P Metalik plava / Metallic blue

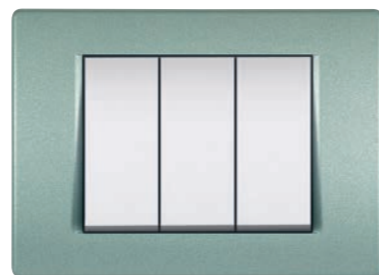
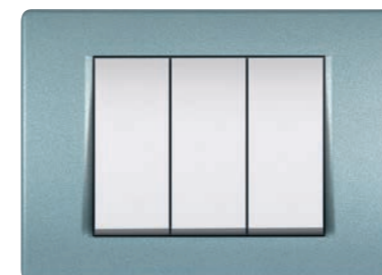

x = Z Metalik zelena / Metallic green



DRVENE
MASKE
WOODEN
DECORATIVE
FRAMES

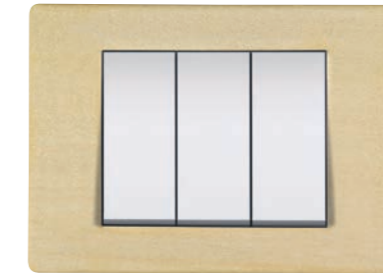

x = J Jasen / Ash



x = H Hrast / Oak



x = R Orah / Nut



x = Y Mahagoni / Mahogany



x = W Wenge / Wenge



DEKORATIVNE MASKE

DECORATIVE FRAMES

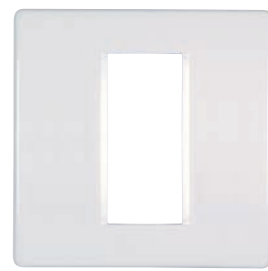

6501.x
Maska 1M
Cover frame 1M

- Za pokrivanje sklopa sa jednim modulom;
- Ugradnja na noseću priрубnicu utiskivanjem
- For covering the assembly with one module;
- Installation onto the mounting frame by pressing

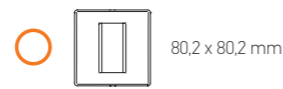

6502.x
Maska 2M
Cover frame 2M

- Za pokrivanje sklopa sa dva modula;
- Ugradnja na noseću priрубnicu utiskivanjem
- For covering the assembly with two modules;
- Installation onto the mounting frame by pressing

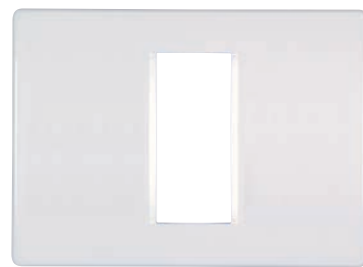

65013.x
Maska 1M/3M
Cover frame 1M/3M

- Za pokrivanje sklopa sa jednim modulom u priрубnici 3M;
- Ugradnja na noseću priрубnicu utiskivanjem
- For covering the assembly with one module into the 3M holding frame;
- Installation onto the mounting frame by pressing

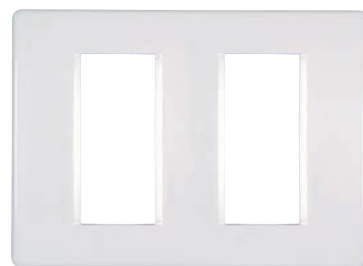
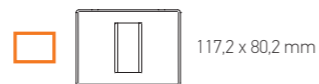

65023.x
Maska 1M+1M/3M
Cover frame 1M+1M/3M

- Za pokrivanje sklopa sa dva modula u priрубnici 3M;
- Ugradnja na noseću priрубnicu utiskivanjem
- For covering the assembly with two modules into the 3M holding frame;
- Installation onto the mounting frame by pressing



65033.x
Maska 2/3M
Cover frame 2/3M

- Za pokrivanje sklopa sa dva modula u priрубnici 3M;
- Ugradnja na noseću priрубnicu utiskivanjem
- For covering the assembly with two modules into the 3M holding frame;
- Installation onto the mounting frame by pressing

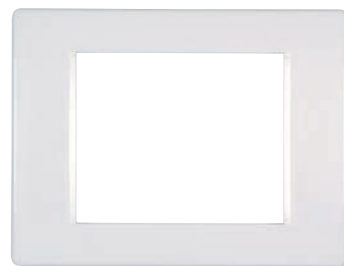

6503.x
Maska 3M
Cover frame 3M

- Za pokrivanje sklopa sa tri modula;
- Ugradnja na noseću priрубnicu utiskivanjem
- For covering the assembly with three modules;
- Installation onto the mounting frame by pressing

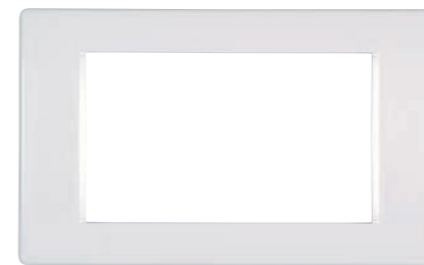

6504.x
Maska 4M
Cover frame 4M

- Za pokrivanje sklopa sa četiri modula;
- Ugradnja na noseću priрубnicu utiskivanjem
- For covering the assembly with four modules;
- Installation onto the mounting frame by pressing

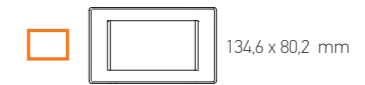

6505.x
Maska 5M
Cover frame 5M

- Za pokrivanje sklopa sa pet modula;
- Ugradnja na noseću priрубnicu utiskivanjem
- For covering the assembly with five modules;
- Installation onto the mounting frame by pressing

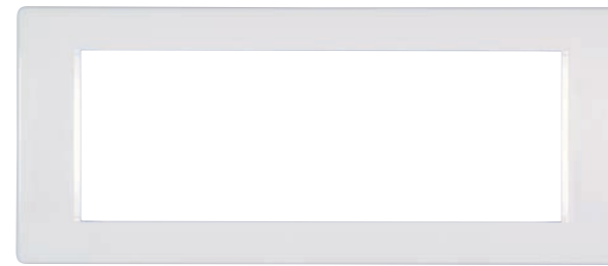
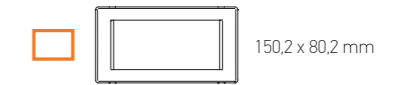

6507.x
Maska 7M
Cover frame 7M

- Za pokrivanje sklopa sa sedam modula;
- Ugradnja na noseću priрубnicu utiskivanjem
- For covering the assembly with seven modules;
- Installation onto the mounting frame by pressing

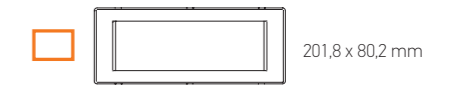

65032.x
Maska 3x2M vertikalna
Cover frame 3x2M vertical

- Za pokrivanje tri sklopa sa dva modula u nizajućim kutijama Ø60;
- Ugradnja na noseću priрубnicu utiskivanjem
- For covering the three assemblies with two modules in mounted box Ø60;
- Installation onto the mounting frame by pressing

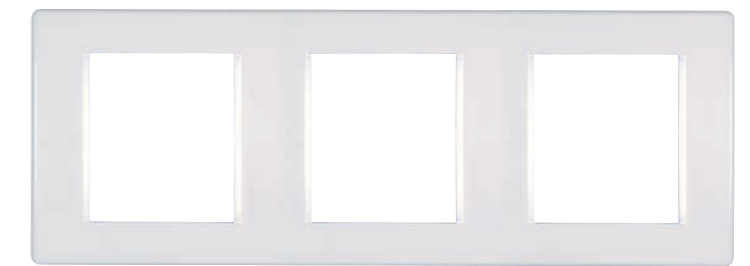
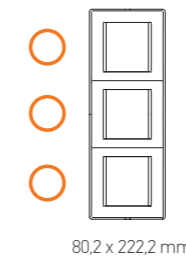

65031.x
Maska 3x2M horizontalna
Cover frame 3x2M horizontal

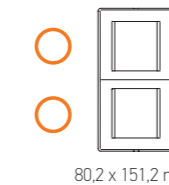
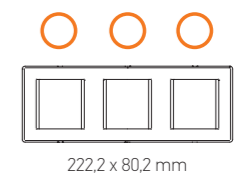

65022.x
Maska 2x2M vertikalna
Cover frame 2x2M vertical

- Za pokrivanje dva sklopa sa dva modula u nizajućim kutijama Ø60;
- Ugradnja na noseću priрубnicu utiskivanjem
- For covering the two assemblies with two modules in mounted box Ø60;
- Installation onto the mounting frame by pressing

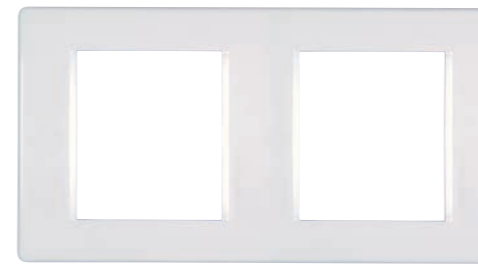

65021.x
Maska 2x2M horizontalna
Cover frame 2x2M horizontal

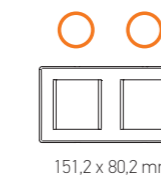

PRIRUBNICE MOUNTING FRAMES

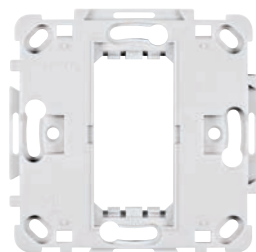

65111

Prirubnica
1M
za šuplji zid
*Mounting
frame 1M
for hollow wall*



- Za ugradnju jednog modula;
- Ugradnja u montažnu kutiju Ø60 pomoću vijaka
- *For one module installation;*
- *Installation into the mounting box Ø60 by screws*



6511

Prirubnica
1M
sa stegačima
*Mounting
frame 1M
with claws*



- Za ugradnju jednog modula;
- Ugradnja u montažnu kutiju Ø60 pomoću stegača
- *For one module installation;*
- *Installation into the mounting box Ø60 by clamps*

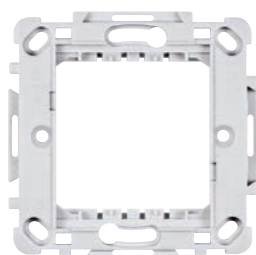

65121

Prirubnica
2M
za šuplji zid
*Mounting
frame 2M
for hollow wall*



- Za ugradnju dva modula;
- Ugradnja u montažnu kutiju Ø60 pomoću vijaka
- *For two module installation;*
- *Installation into the mounting box Ø60 by screws*

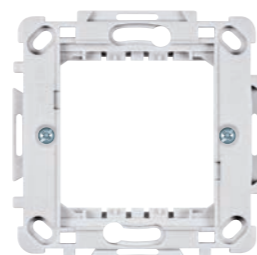

6512

Prirubnica
2M
sa stegačima
*Mounting
frame 2M
with claws*



- Za ugradnju dva modula;
- Ugradnja u montažnu kutiju Ø60 pomoću stegača
- *For two module installation;*
- *Installation into the mounting box Ø60 by clamps*

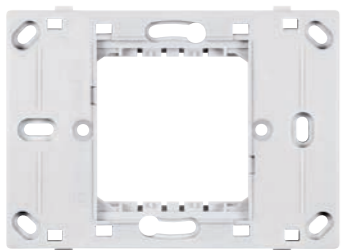

65134

Prirubnica
2/3M
za šuplji zid
*Mounting
frame 2/3M
for hollow wall*



- Za ugradnju dva modula;
- Ugradnja u montažnu kutiju Ø60 ili 3M pomoću vijaka

- *For two module installation;*
- *Installation into the mounting box Ø60 or 3M by screws*

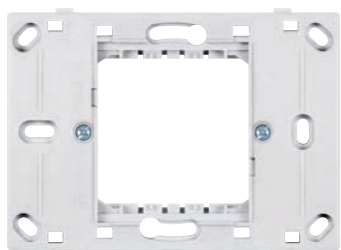

65133

Prirubnica
2/3M
sa stegačima
*Mounting
frame 2/3M
with claws*



- Za ugradnju dva modula;
- Ugradnja u montažnu kutiju Ø60 ili 3M pomoću stegača

- *For two module installation;*
- *Installation into the mounting box Ø60 or 3M by clamps*

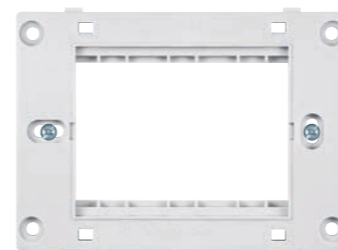

6513

Prirubnica
3M
sa vijcima
*Mounting
frame 3M
with screws*



- Za ugradnju tri modula;
- Ugradnja u montažnu kutiju 3M pomoću vijaka

- *For three module installation;*
- *Installation into the mounting box by screws*



6514

Prirubnica
4M
sa vijcima
*Mounting
frame 4M
with screws*



- Za ugradnju četiri modula;
- Ugradnja u montažnu kutiju 4M pomoću vijaka

- *For four module installation;*
- *Installation into the mounting box by screws*



6515

Prirubnica
5M
sa vijcima
*Mounting
frame 5M
with screws*



- Za ugradnju pet modula;
- Ugradnja u montažnu kutiju 5M pomoću vijaka

- *For five module installation;*
- *Installation into the mounting box by screws*



6517

Prirubnica
7M EXP
sa vijcima
*Mounting
frame 7M EXP
with screws*



- Za ugradnju sedam modula;
- Ugradnja u montažnu kutiju 7M pomoću vijaka

- *For seven module installation;*
- *Installation into the mounting box by screws*



65122.x

Kutija nadgradna
2M za na zid
Wall mounted box 2M

- Za ugradnju dva modula;
- Ugradnja na zid pomoću vijaka

- *For two module installation;*
- *Wall mounting with screws*



65142.x

Kutija nadgradna
4M za na zid
Wall mounted box 4M

- Za ugradnju četiri modula;
- Ugradnja na zid pomoću vijaka

- *For four module installation;*
- *Wall mounting with screws*



65172.x

Kutija nadgradna
7M za na zid
Wall mounted box 7M

- Za ugradnju sedam modula;
- Ugradnja na zid pomoću vijaka

- *For seven module installation;*
- *Wall mounting with screws*

- Bela
White **x = 0**
- Siva
Grey **x = 1**



- • Montažne kutije Ø60
• Installation boxes Ø60

- • Montažne kutije za modularni program
• Installation boxes for modular program

MONTAŽNE KUTIJE ZA PUNI ZID
INSTALLATION BOXES FOR SOLID WALL

* Halogen free



650°C, 500V~

700

Montažna kutija
Ø60 x 40 mm
nizajuća za
rastojanje 71mm

*Two-gang
installation box
Ø60 x 40 mm
for sequencing
71mm step*

710

Montažna kutija
Ø60 x 60 mm
nizajuća za
rastojanje 71mm

*Two-gang
installation box
Ø60 x 60 mm
for sequencing
71mm step*

800

Montažna kutija
Ø60 x 40 mm
nizajuća za
rastojanje 80mm

*Two-gang
installation box
Ø60 x 40 mm
for sequencing
80mm step*

- Usaglašeno sa IEC 60570-1
- Ugradnja u zid,
- Mogućnost instalacije pomoću stegača ili vijaka
- *Compiled with IEC 60670-1*
- *Flush mounted,*
- *Accessory installation by clamps or screw*



650°C, 400V~

6523

Montažna kutija
PM3 za 3M
za puni zid, 50 mm

*Two-gang
installation box
PM3 for 3M
for solid wall, 50 mm*

65236

Montažna kutija
PM3 za 3M
za puni zid, 65 mm

*Two-gang
installation box
PM3 for 3M
for solid wall, 65 mm*

- Kutija za ugradnju trostruke prirubnice;
- Ugradnja u puni zid pod malter
- *Mounting box for three gang mounting frame;*
- *Installation into the solid wall*



650°C, 400V~

6524

Montažna kutija
PM4 za 4M
za puni zid, 50 mm

*Four-gang
installation box
PM4 for 4M
for solid wall, 50 mm*

65246

Montažna kutija
PM4 za 4M
za puni zid, 65 mm

*Four-gang
installation box
PM4 for 4M
for solid wall, 65 mm*

- Kutija za ugradnju četvorostruke prirubnice;
- Ugradnja u puni zid pod malter
- *Mounting box for four gang mounting frame;*
- *Installation into the solid wall*



650°C, 400V~

6525

Montažna kutija
PM5 za 5M
za puni zid, 50 mm

*Five-gang
installation box
PM5 for 5M
for solid wall, 50 mm*

- Kutija za ugradnju petostruke prirubnice;
- Ugradnja u puni zid pod malter
- *Mounting box for five gang mounting frame;*
- *Installation into the solid wall*



650°C, 400V~

6527

Montažna kutija
PM7 za 7M
za puni zid, 50 mm

*Seven-gang
installation box
PM7 for 7M
for solid wall, 50 mm*

65276

Montažna kutija
PM7 za 7M
za puni zid, 65 mm

*Seven-gang
installation box
PM7 for 7M
for solid wall, 65 mm*

- Kutija za ugradnju sedmorostruke prirubnice;
- Ugradnja u puni zid pod malter
- *Mounting box for seven gang mounting frame;*
- *Installation into the solid wall*



MONTAŽNE KUTIJE ZA ŠUPLJI ZID
INSTALLATION BOXES FOR HOLLOW WALL



850°C, 400V~

711

Montažna kutija
Ø60 x 40 mm
za šuplji zid

*Two-gang
installation box
Ø60 x 40 mm
for hollow wall*

- Ugradnja u šuplji zid pomoću kandži sa vijcima
- *Installation into the hollow wall by screw clamps*

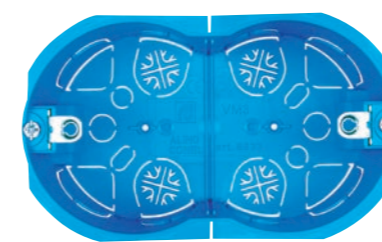

850°C, 400V~

6533

Montažna kutija
VM3 za 3M
za šuplji zid, 50 mm

*Two-gang
installation box
VM3 for 3M
for hollow wall, 50 mm*

- Kutija za ugradnju trostruke prirubnice;
- Ugradnja u šuplji zid pomoću kandži sa vijcima
- *Mounting box for three gang mounting frame;*
- *Installation into the hollow wall by screw clamps*

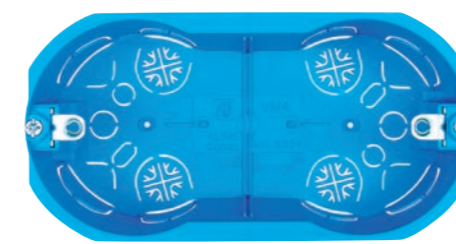

850°C, 400V~

6534

Montažna kutija
VM4 za 4M
za šuplji zid, 50 mm

*Four-gang
installation box
VM4 for 4M
for hollow wall, 50 mm*

- Kutija za ugradnju četvorostruke prirubnice;
- Ugradnja u šuplji zid pomoću kandži sa vijcima
- *Mounting box for four gang mounting frame;*
- *Installation into the hollow wall by screw clamps*

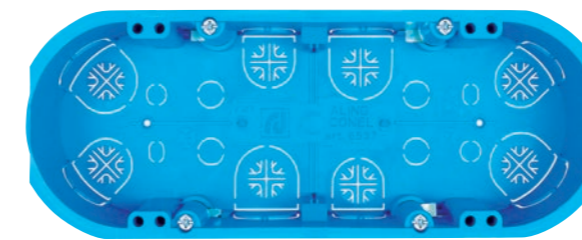

850°C, 400V~

6537

Montažna kutija
VM7 za 6M/7M
za šuplji zid, 50 mm

*Seven-gang
installation box
VM7 for 6M/7M
for hollow wall, 50 mm*

- Kutija za ugradnju sedmorostruke prirubnice;
- Ugradnja u šuplji zid pomoću kandži sa vijcima
- *Mounting box for seven gang mounting frame;*
- *Installation into the hollow wall by screw clamps*



71202

Set vijaka M3,5 x 20
pakovanje 100 kom
*Screw set M3,5 x 20
pack. 100 pcs.*



71203

Set vijaka M3,5 x 35
pakovanje 50 kom
*Screw set M3,5 x 35
pack. 50 pcs.*

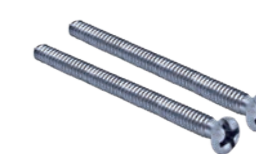

71204

Set vijaka M3,5 x 50
pakovanje 50 kom
*Screw set M3,5 x 50
pack. 50 pcs.*

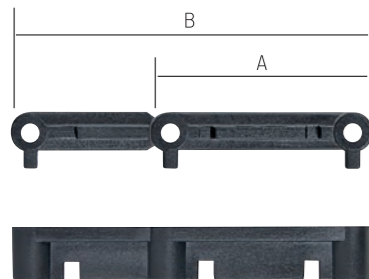

6529

Odstojnik za postavljanje montažnih kutija
Spacer for installation box placement

- Odstojnik za postavljanje montažnih kutija za puni zid prilikom nizanja više sklopova;
- Ugradnja na montažnu kutiju utiskivanjem sa donje strane
- *Spacer for solid wall installation boxes placement in case of assembly chaining;*
- *Installation onto the underside installation box by pressing*

Da bi se obezbedilo nizanje više sklopova kod ugradnje montažnih kutija u pune zidove potrebno je staviti odstoynike koji obezbeđuju tačan položaj kutija. Time se postiže pravilan međusobni raspored pokrivnih maski.

Sklopovi se mogu nizati horizontalno i tada je moguće spajanje kutija različite veličine.

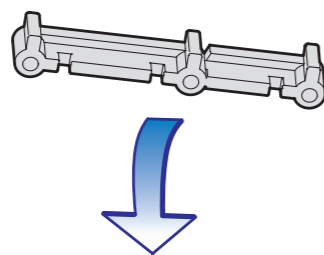

In order to provide series of more assemblies when installing the installation boxes into the solid walls it is necessary to insert the spacers which determine the correct position of boxes. So it is possible to achieve the correct arrangement between the covering frames.

The assemblies can be followed in a row horizontally and then it is possible to connect the installation boxes of various sizes.

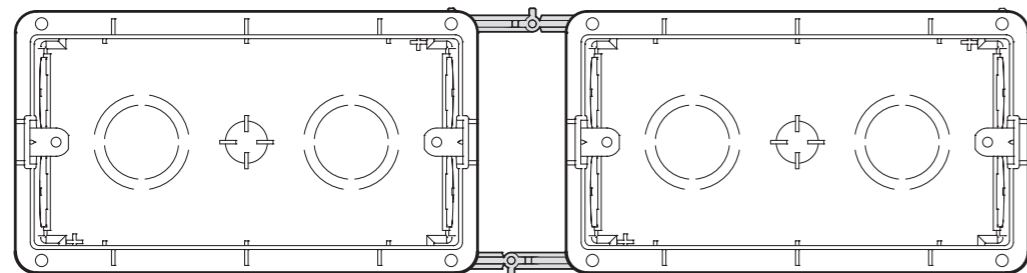

Ili vertikalno, gde se mogu nizati samo kutije iste veličine.

Or vertically, where only the boxes of the same size can follow in a row.

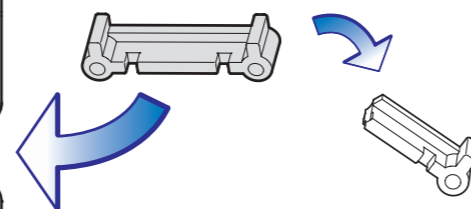
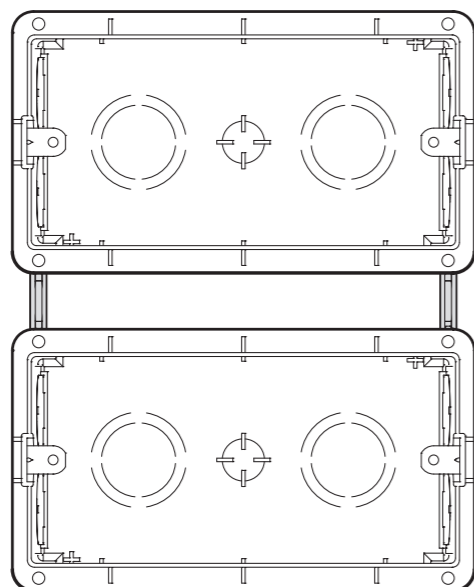

Kod vertikalnog nizanja potrebno je odstraniti deo odstoynika kao na slici.

In vertical series, spacers need to be break a part, shown on picture.

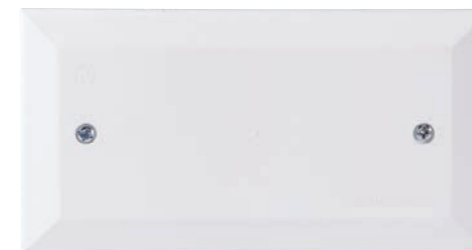

65232.0

Poklopac za kutiju PM3/VM3, beli
Ornamental cover for PM3/VM3, white

- Montaža kutije za 3, 4 i 7 modula poseduje posebne ukrasne poklopce koji se na kutiju pričvršćuju vijcima. Poklopci imaju višestruku namenu i obezbeđuju sledeće:
 - Mogućnost korišćenja montažnih kutija, kao razvodne instalacione kutije.
 - Mogućnost da se izvede dodatna instalacija koja će se naknadno povezati i koristiti,
 - Mogućnost upotrebe montažnih kutija kao kutija za izjednačenje potencijala uz primenu odgovarajućih rednih stezaljki.

65242.0

Poklopac za kutiju PM4/VM4, beli
Ornamental cover for PM4/VM4, white

65272.0

Poklopac za kutiju PM7/VM7, beli
Ornamental cover for PM7/VM7, white

- *The installation boxes for 3, 4 or 7 modules have the special ornamental covers to be fixed to the box by screws. The covers are intended for multipurpose application and provide the following:*
 - *Possibility of using the installation boxes as the junction boxes.*
 - *Possibility of conneting and using the additional installations.*
 - *Possibility of usinf the installation boxes as potential equalizing boxes by applying, the appropriate block terminals.*

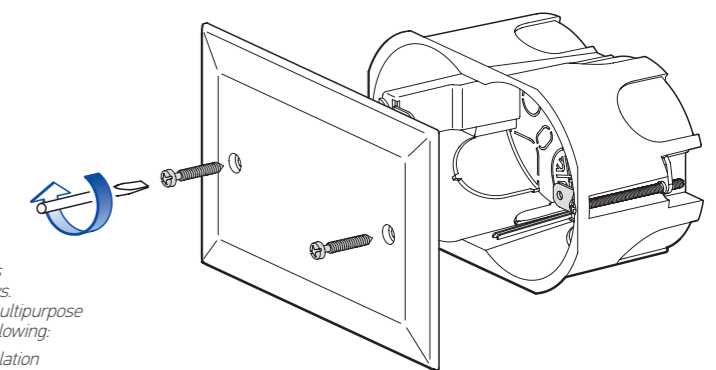

- Poklopac za zatvaranje montažne kutije kada se koristi kao razvodna ili za izjednačenje potencijala;
- Ugradnja na montažnu kutiju vijcima

- *Cover for mounting box when is used as junction box or equipotentialing;*
- *Installation onto the mounting box by screws*

* Halogen free



65231.0

Zaštitni poklopac za kutiju PM3
Protecting cover for PM3 installation box

- Kod ugradnje montažnih kutija u pune zidove unutrašnjost kutije se zaštićuje zaštitnim poklopcem koji prilikom malterisanja zidova obezbeđuje nesmetani rad.
- Nakon sušenja maltera poklopac se jednostavno izvadi zajedno sa delom maltera koji je preko njega.
- Unutrašnjost kutije i provodnici ostaju čisti.

65241.0

Zaštitni poklopac za kutiju PM4
Protecting cover for PM4 installation box

- *When installing, the installation boxes into the solid wals, the internal parts of the box are to be protected by the protecting cover which provides the trouble-free wall plastering.*
- *After drying, the cover can be simply taken out together with a part of plaster over it.*
- *The internal part of the box and the conducting wires remain clean.*

65271.0

Zaštitni poklopac za kutiju PM7
Protecting cover for PM7 installation box

- Poklopac za zaštitu kutije i provodnika prilikom malterisanja;
- Snabdeven signalnim pipcima radi lakšeg pronalaženja nakon malterisanja;
- Ugradnja na montažnu kutiju utiskivanjem

- *Protective cover for mounting box and conducting wires during plastering;*
- *With signal extensions for easier finding after plastering;*
- *Installation onto the mounting box by pressing*

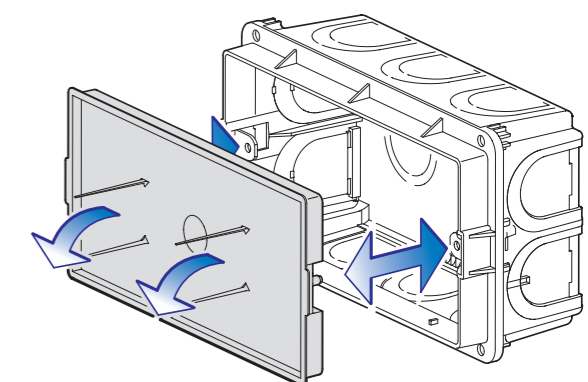

ANTIBAKTERIJSKI PROGRAM ANTIBACTERIAL PROGRAM



A6541.0
Taster 1M
za sklopke
bez indikacije
*Button 1M
for switches
without
indication*



A6581.0
Taster 2M
za sklopke
bez indikacije
*Button 2M
for switches
without
indication*

- Ugradnja na sklopku utiskivanjem
- *Installation onto the switch by pressing*



A6542.0
Taster 1M
za sklopke
sa indikacijom
*Button 1M
for switches
with indication*



A6582.0
Taster 2M
za sklopke
sa indikacijom
*Button 2M
for switches
with indication*

- Ugradnja na sklopku utiskivanjem
- *Installation onto the switch by pressing*



A651.0
Prikjučnica
dvopolna
16A 250V~ 2M
*2 pole
socket outlet
16A 250V~ 2M*

- Usaglašeno sa IEC 60884-1
- Ugradnja u noseću priрубnicu utiskivanjem
- *Complied with IEC 60884-1*
- *Installation into the mounting frame by pressing*



A6500.0
Poklopac maske
(slepi modul) 1M
Blank module 1M

- Za pokrivanje mesta gde nedostaje modul
- Ugradnja u noseću priрубnicu utiskivanjem
- *For covering the places where module is missing*
- *Installation into the holding frame by pressing*



A653.0
Priključnica
dvopolna
sa poklopcem
16A 250V~ 2M
*2 pole socket
outlet with cover
16A 250V~ 2M*

- Usaglašeno sa IEC 60884-1
- Ugradnja u noseću priрубnicu utiskivanjem
- *Complied with IEC 60884-1*
- *Installation into the mounting frame by pressing*



A6519.0
Keystone nosač 1M
Keystone holder 1M

- Modul širine 22,2mm za nošenje Keystone konektora
- Ugradnja u noseću priрубnicu utiskivanjem
- *Module 22,2mm width for Keystone connectors holding*
- *Installation into the mounting frame by pressing*



A652.0
Priključnica dvopolna
CEI 23-50/P11
italijanska
10A 250V~ 1M,
*2 pole socket outlet
CEI 23-50/P11
italian type
10A 250V~ 1M*

- Usaglašeno sa CEI 23-50/P11;
- Ugradnja u noseću priрубnicu utiskivanjem
- *Complied with CEI 23-50/P11;*
- *Installation into the mounting frame by pressing*



A65190.0
ELine nosač 1M
ELine holder 1M

- Modul širine 22,2mm za nošenje ELine konektora
- Ugradnja u noseću priрубnicu utiskivanjem
- *Module 22,2mm width for ELine connectors holding*
- *Installation into the mounting frame by pressing*

ČUVAR VAŠEG ZDRAVLJA

- Antibakterijski program izrađen u standardnom ALING MODE dizajnu i isključivo u beloj boji ima funkciju zaštite korisnika od prenošenja bakterija, virusa, mikroba i gljivica čestim dodirivanjem. Dnevno više korisnika dodiruje tastere sklopki, maske i blokove priključnica. Ovo je naročito izraženo u javnim i zdravstvenim ustanovama tako da je prednja površina idealno mesto za razvoj i širenje bakterija.
- Specijalni aditivi na bazi srebrnih jona koji se dodaju u plastične mase tokom vremena uništavaju i sprečavaju dalje širenje bakterija na površini plastike. Zahvaljujući ovim karakteristikama srebra postiže se veoma efikasna i dugotrajna zaštita zdravlja svih korisnika koji dolaze u dodir sa sklopkama, maskama i priključnicama.
- Prvenstveno je značajna primena u svim prostorima gde se zahteva visok stepen higijene kao što su bolnice i druge zdravstvene ustanove, restorani, autobuske i železničke stanice, aerodromi, školske ustanove, stanovi sa bolesnim osobama osetljivim na bakterije i viruse, stanovi zdravstvenih radnika, trgovinski i poslovni centri, javne ustanove (sudovi, opštine, muzeji, bioskopi, sportski objekti i sl.).
- Proizvodi su testirani u skladu sa standardom JIS Z 2801 i poseduju visok stepen redukcije bakterija na površini plastike.
- Održavanje i čišćenje se sprovodi isto kao i kod proizvoda koji nemaju antibakterijsku zaštitu.
- Proizvodi su identični kao i standardni program sa dodatom oznakom A ispred oznake proizvoda.
- Sve maske antibakterijskog programa označene su znakom raspoznavanja



YOUR HEALTH GUARDIAN

- *Antibacterial program made in standard ALING MODE design and exclusively in white color has a function to protect user from transmission of bacterial, viruses, microbes and fungi during the often touching. During the day more users touches the switch buttons, covering frames and socket blocks. It is especially expressed in the public and medical institutions, so that the front surface is perfect place for growth and spread of bacteria.*
- *The special additives on silver ions that were added to plastic compounds damage and block bacteria spread on the plastic surface. With the help of this silver characteristic there is very effective and long term protection of health for all users which are in contact with switches, covering frames and sockets.*
- *At the first time application is important at the places where a high level of hygiene is required like hospitals and other medical institutions, restaurants, bus and train stations, airports, schools, apartments with the sick persons which are sensitive on bacteria and viruses, medical employees apartments, shopping and business centers, public institutions (courthouses, townships, museums, cinemas, sport arenas).*
- *The products are tested according the standard JIS Z 2801 and they have a high level of bacteria reduction on plastic surface.*
- *Cleaning and maintenance is same like products without antibacterial protection.*
- *Products are identical with standard program with additional mark A ahead of product mark.*
- *All covering frames are marked with sign of recognition*



A6621.0
Priključnica antenska
TV IEC M / F 1M
za individualne sisteme
*TV aerial socket
IEC M/F 1M
for individual systems*

- Usaglašeno sa IEC 169-2 - muški konektor;
- Montaža antenskog kabla preko F konektora;
- Bez prigušenja signala;
- Ugradnja u noseću priрубnicu utiskivanjem

- *Complied with IEC 169-2 - M connector;*
- *Installation of aerial cable by F connector;*
- *Without signal attenuation; I*
- *Installation into the mounting frame by pressing*



A6622.0
Priključnica
antenska FM,
IEC F / F 1M
*FM aerial
socket
IEC F/F 1M*

- Usaglašeno sa IEC 169-2 - ženski konektor;
- Montaža antenskog kabla preko F konektora;
- Bez prigušenja signala;
- Ugradnja u noseću priрубnicu utiskivanjem

- *Complied with IEC 169-2 - F connector;*
- *Installation of aerial cable by F connector;*
- *Without signal attenuation; I*
- *Installation into the mounting frame by pressing*



A6625.0
Priključnica
antenska TV F/F
za individualne
sisteme SAT 1M
*TV aerial
socket F/F
for individual
systems 1M*

- Završna za satelitske antene;
- Montaža antenskog kabla preko F konektora;
- Bez prigušenja signala;
- Ugradnja u noseću priрубnicu utiskivanjem

- *Terminal for satellite aerals;*
- *Installation of aerial cable by F connector;*
- *Without signal attenuation;*
- *Installation into the mounting frame by pressing*



A6627.0
Priključnica
audio 2xRCA 1M
*Audio socket
2XRCA 1M*

- Za prenos audio signala - stereo;
- Montaža provodnika lemljenjem;
- Ugradnja u noseću priрубnicu utiskivanjem

- *For the transmission of audio signals stereo;*
- *Installation of conducting wires by soldering;*
- *Installation into the mounting frame by pressing*

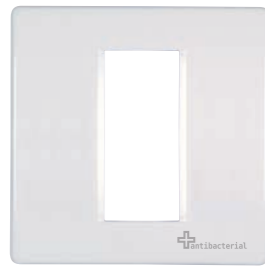

A6501.0
Maska 1M
Cover frame 1M

- Za pokrivanje sklopa sa jednim modulom;
- Ugradnja na noseću priрубnicu utiskivanjem
- For covering the assembly with one module;
- Installation onto the mounting frame by pressing



A6502.0
Maska 2M
Cover frame 2M

- Za pokrivanje sklopa sa dva modula;
- Ugradnja na noseću priрубnicu utiskivanjem
- For covering the assembly with two modules;
- Installation onto the mounting frame by pressing

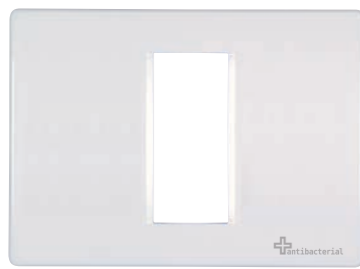

A65013.0
Maska 1M/3M
Cover frame 1M/3M

- Za pokrivanje sklopa sa jednim modulom u priрубnici 3M;
- Ugradnja na noseću priрубnicu utiskivanjem
- For covering the assembly with one module into the 3M holding frame;
- Installation onto the mounting frame by pressing

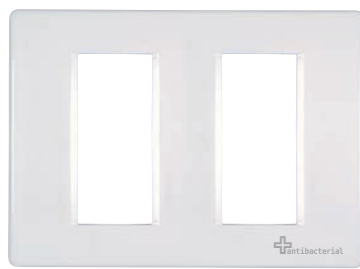

A65023.0
Maska 1M+1M/3M
Cover frame 1M+1M/3M

- Za pokrivanje sklopa sa dva modula u priрубnici 3M;
- Ugradnja na noseću priрубnicu utiskivanjem
- For covering the assembly with two modules into the 3M holding frame;
- Installation onto the mounting frame by pressing

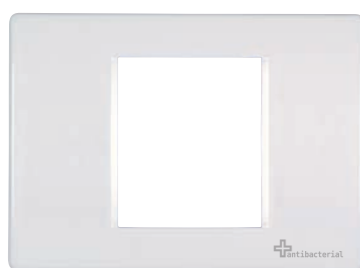

A65033.0
Maska 2/3M
Cover frame 2/3M

- Za pokrivanje sklopa sa dva modula u priрубnici 3M;
- Ugradnja na noseću priрубnicu utiskivanjem
- For covering the assembly with two modules into the 3M holding frame;
- Installation onto the mounting frame by pressing



A6503.0
Maska 3M
Cover frame 3M

- Za pokrivanje sklopa sa tri modula;
- Ugradnja na noseću priрубnicu utiskivanjem
- For covering the assembly with three modules;
- Installation onto the mounting frame by pressing



A6504.0
Maska 4M
Cover frame 4M

- Za pokrivanje sklopa sa četiri modula;
- Ugradnja na noseću priрубnicu utiskivanjem
- For covering the assembly with four modules;
- Installation onto the mounting frame by pressing

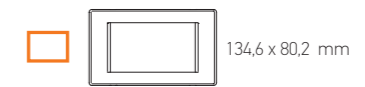

A6505.0
Maska 5M
Cover frame 5M

- Za pokrivanje sklopa sa pet modula;
- Ugradnja na noseću priрубnicu utiskivanjem
- For covering the assembly with five modules;
- Installation onto the mounting frame by pressing

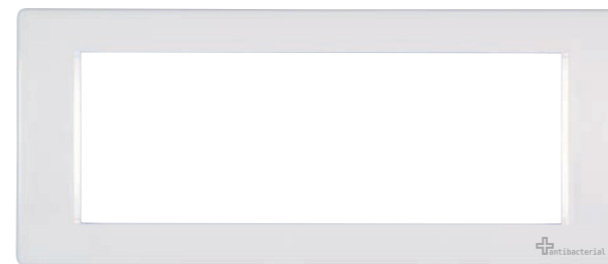
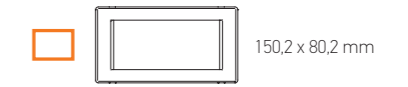

A6507.0
Maska 7M
Cover frame 7M

- Za pokrivanje sklopa sa sedam modula;
- Ugradnja na noseću priрубnicu utiskivanjem
- For covering the assembly with seven modules;
- Installation onto the mounting frame by pressing

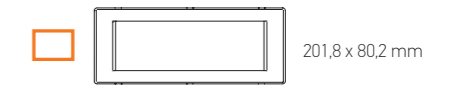

A65032.0
Maska 3x2M vertikalna
Cover frame 3x2M vertical

- Za pokrivanje tri sklopa sa dva modula u nizajućim kutijama Ø60;
- Ugradnja na noseću priрубnicu utiskivanjem
- For covering the three assemblies with two modules in mounted box Ø60;
- Installation onto the mounting frame by pressing

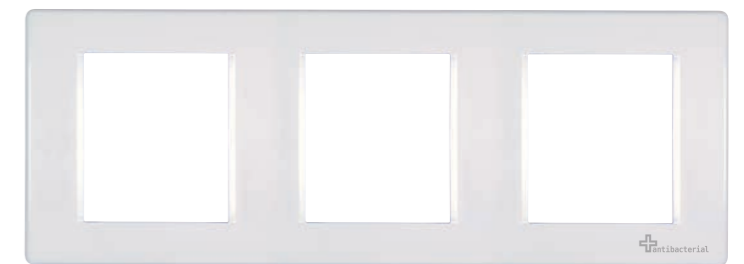
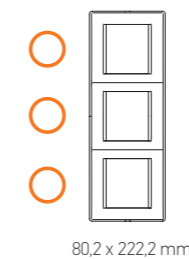

A65031.0
Maska 3x2M horizontalna
Cover frame 3x2M horizontal

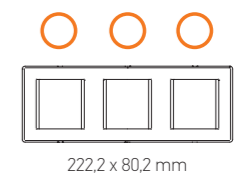

A65022.0
Maska 2x2M vertikalna
Cover frame 2x2M vertical

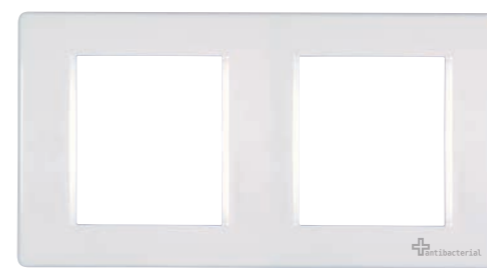

- Za pokrivanje dva sklopa sa dva modula u nizajućim kutijama Ø60;
- Ugradnja na noseću priрубnicu utiskivanjem
- For covering the two assemblies with two modules in mounted box Ø60;
- Installation onto the mounting frame by pressing

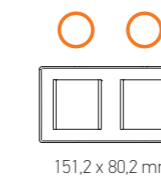

A65021.0
Maska 2x2M horizontalna
Cover frame 2x2M horizontal



HOTELSKI PROGRAM HOTEL PROGRAM

	Bela White	x = 0
	Antracit Anthracite	x = A
	Krem Beige	x = 9



6960.x RM.CHA.01

Držač RFID kartica
RFID card holder



- Predefinisana funkcionalnost držača RFID kartica u hotelskim sobama
- Programabilnost uređaja omogućava dodavanje novih i izmenu postojećih funkcionalnosti
- Podržava MIFARE® 1K RFID kartice
- LED osvetljenje procepa za ubacivanje kartice
- Komunikacija sa ostatkom sistema preko Modbus RTU ili BACnet MS/TP komunikacionih protokola

- *Predefined RFID card holder functionality for hotels*
- *Device programmability enables adding of new and changing of existing functionalities*
- *Support for MIFARE® 1K RFID cards*
- *LED light for marking card insertion slot*
- *The device communicates with the resto of the system using either Modbus RTU or BACnet MS/TP protocol*



RM.CHA.01 je programabilan uređaj predviđen za odlaganje ključ kartica u hotelskim sobama. Uređaj radi sa MIFARE® 1K RFID karticama i dolazi sa predefinisanim funkcionalnošću detekcije kartica koje odgovaraju dotičnoj sobi.

Zahvaljujući programabilnosti moguće je dodavati nove ili menjati postojeće funkcionalnosti. Za programiranje i parametризaciju uređaja koristi se besplatna PC aplikacija.

RM.CHA.01 is programmable device designed for placement of the key cards in hotel rooms. Device communicates with MIFARE® 1K RFID cards and comes with predefined functionality of detecting correct cards for associated room.

Thanks to its programmability it is possible to add new or modify existing functionalities. A free PC based application is used for programming and parametrization.



6961.x RM.CRA.01

Čitač RFID kartica
RFID Card Reader



- Predefinisana funkcionalnost panela za pristup hotelskoj sobi
- Programabilnost uređaja omogućava dodavanje novih i izmenu postojećih funkcionalnosti
- Podržava MIFARE® 1K RFID kartice
- Taster za aktiviranje zvona
- 4 LED indikatora sa predefinisanim funkcionalnošću prikaza informacija: zauzetost sobe, ne uznemiravaj, SOS i zahteva za čišćenje sobe.
- Komunikacija sa ostatkom sistema preko Modbus RTU ili BACnet MS/TP komunikacionih protokola

- *Predefined functionality for hotel room access panel*
- *Device programmability enables adding of new and changing of existing functionalities*
- *Support for MIFARE® 1K RFID cards*
- *Doorbell push button*
- *4 LED indicators showing information about: room occupancy status, do not disturb, SOS and clean my room*
- *The device communicates with the resto of the system using either Modbus RTU or BACnet MS/TP protocol*



RM.CRA.01 je programabilan uređaj predviđen za postavljanje ispred hotelske sobe. Uređaj radi sa MIFARE® 1K RFID karticama i dolazi sa predefinisanim funkcionalnošću očitavanja ključ kartica koje odgovaraju dotičnoj sobi kao i prikaza zahteva korisnika: soba zauzeta, ne ometaj, SOS i zahteva za čišćenje sobe.

Zahvaljujući programabilnosti moguće je dodavati nove ili menjati postojeće funkcionalnosti. Za programiranje i parametризaciju uređaja koristi se besplatna PC aplikacija.

RM.CRA.01 is programmable device designed to be placed in front of the hotel rooms. Device communicates with MIFARE® 1K RFID cards and comes with predefined functionality of reading key cards for associated hotel room and for displaying info about guest demands.

Thanks to its programmability it is possible to add new or modify existing functionalities. A free PC based application is used for programming and parametrization.



6962.x RM.RDA.01

Sobna kontrolna jedinica
Remote Display Unit



- Predefinisana funkcionalnost – kontrola zadate temperature i brzine ventilatora klima uređaja, aktiviranje DND (ne ometaj) i SOS signala kao i poziv osoblju
- Programabilnost uređaja omogućava dodavanje novih i izmenu postojećih funkcionalnosti
- 7 tastera
- 1,8" TFT displej sa pozadinskim osvetljenjem
- Ugrađena sonda za merenje temperature vazduha u sobi
- Komunikacija sa ostatkom sistema preko Modbus RTU ili BACnet MS/TP komunikacionih protokola

- *Predefined functionality – control of temperature set point and fan speed of air-condition unit, activation of do not disturb, SOS and clean my room signals.*
- *Device programmability enables adding of new and changing of existing functionalities*
- *7 pushbuttons*
- *1.8" TFT display with backlight*
- *Embedded temperature probe for air temperature measurement*
- *The device communicates with the resto of the system using either Modbus RTU or BACnet MS/TP protocol*



RM.RDA.01 je programabilni uređaj predviđen za kontrolu klime u hotelskim sobama kao i prihvatanje dodatnih zahteva gosta. Uređaj se isporučuje sa predefinisanim funkcionalnošću ali zahvaljujući programabilnosti moguće je dodavati nove ili menjati postojeće funkcionalnosti. Za programiranje i parametризaciju uređaja koristi se besplatna PC aplikacija. Uređaj poseduje kolor TFT displej dijagonale 1,8" sa pozadinskom osvetljenjem i 7 tastera. Temperatura vazduha se meri preko ugrađene sonde.

RM.RDA.01 is programmable device designed for control of the air-condition units and accepting of additional guest commands in hotel rooms. Device is shipped with predefined functionality but thanks to its programmability it is possible to add new or modify existing functionalities. A free PC based application is used for programming and parametrization. The device features color 1.8" TFT display with backlight and 7 pushbuttons. Room air temperature is measured using embedded probe.



6963.x RM.KPA.01

Sobna kontrolna jedinica
Room Keypad



- Predefinisana funkcionalnost – upravljanje osvetljenjem
- Programabilnost uređaja omogućava dodavanje novih i izmenu postojećih funkcionalnosti
- Do 12 tastera
- Komunikacija sa ostatkom sistema preko Modbus RTU ili BACnet MS/TP komunikacionih protokola

- *Predefined functionality – light control*
- *Device programmability enables adding of new and changing of existing functionalities*
- *Up to 12 pushbuttons*
- *The device communicates with the resto of the system using either Modbus RTU or BACnet MS/TP protocol*



RM.KPA.01 je programabilni uređaj predviđen za upravljanje dimabilnim svetlima u hotelskim sobama. Uređaj se isporučuje sa predefinisanim funkcionalnošću ali zahvaljujući programabilnosti moguće je dodavati nove ili menjati postojeće funkcionalnosti. Za programiranje i parametризaciju uređaja koristi se besplatna PC aplikacija. Broj tastera je moguće birati u toku proizvodnje i može ih biti do 12.

RM.KPA.01 is programmable device designed for control of dimmable lights. The device is shipped with predefined functionality but thanks to its programmability it is possible to add new or modify existing functionalities. A free PC based application is used for programming and parametrization. The device can have up to 12 buttons, the exact number is chosen according to the customer needs during production.



ŠEME VEZIVANJA
WIRING DIAGRAMS

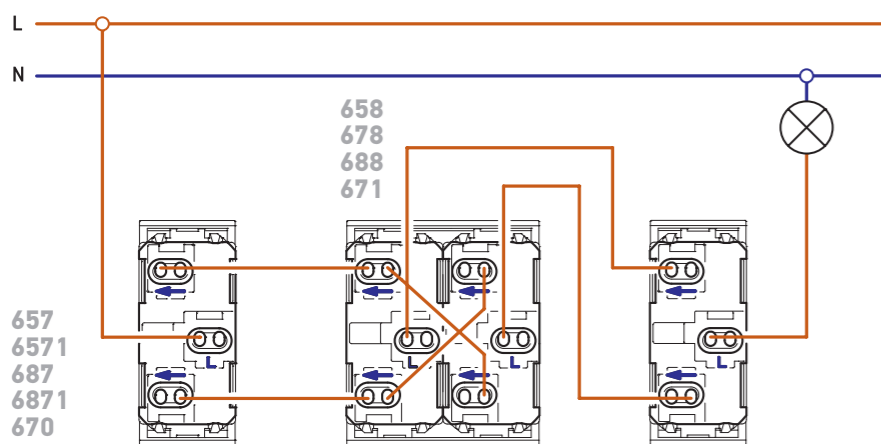
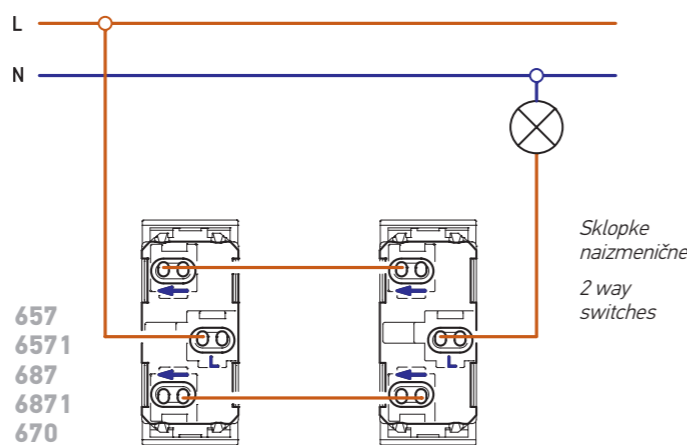
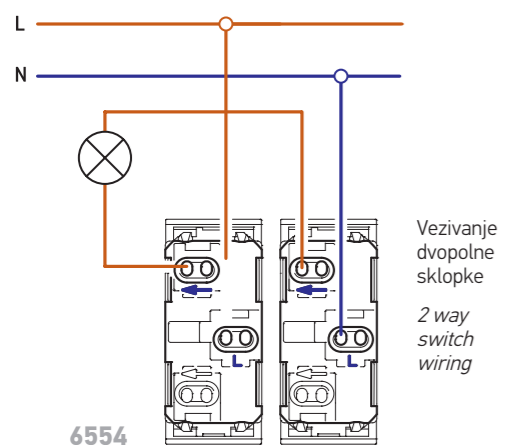
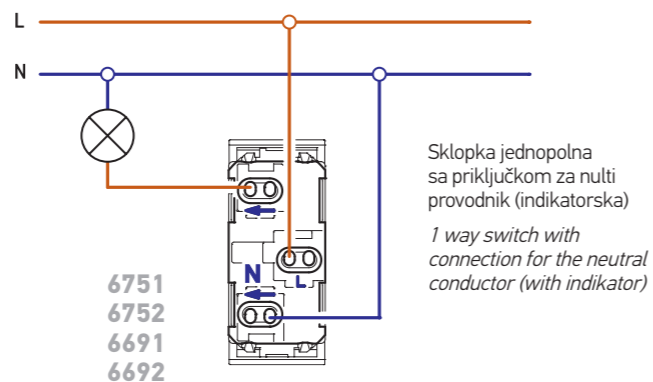
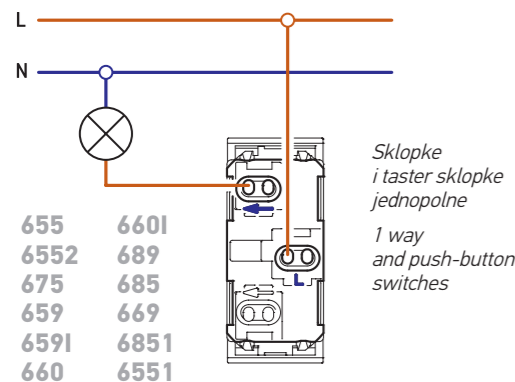

Ukrsne sklopke se povezuju ukrštanjem priključaka na dvostrukom modulu. Ukrsne sklopke takođe imaju izvedbu sa indikatorom koja svetli kada je strujno kolo otvoreno. Može se povezivati neograničen broj ukrasnih sklopki u kombinaciji sa dve naizmjenične.

Cross-switches are wired by crossing the terminals on double module. The cross-switches may also have the indication which turns on when the circuit is open. It is possible to connect the unlimited number of cross-switches in combination with two alternative switches.

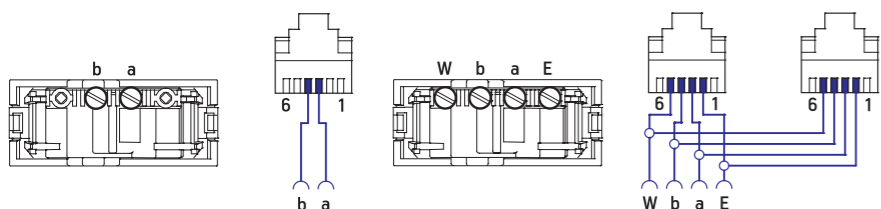

Telefonske priključnice sa standardnim RJ12 konektorima u saglasnosti sa IEC 60603-7 u kombinaciji 6/2 i 6/4 kontakta. Povezivanje se vrši prema priloženim šemama gde su kontakti a i b osnovna linija, a W i E kontakti druge parice za analogni terminal (prema internacionalnom standardu).

Telephone sockets with standard RJ12 connectors in compliance with IEC 60603-7 in combination 6/2 and 6/4 contacts. Wiring is carried out according to the attached diagrams where the contacts a and b are the basic terminal, and W and E contacts of the second pair are for analog terminal (according to international standard).

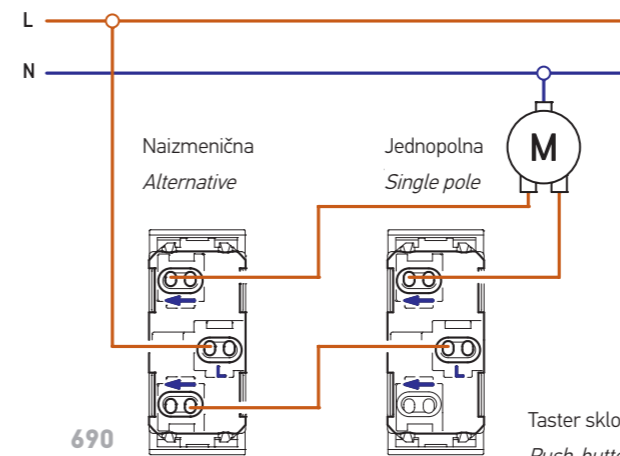

Taster sklopke za roletne
Push-button shutters switches

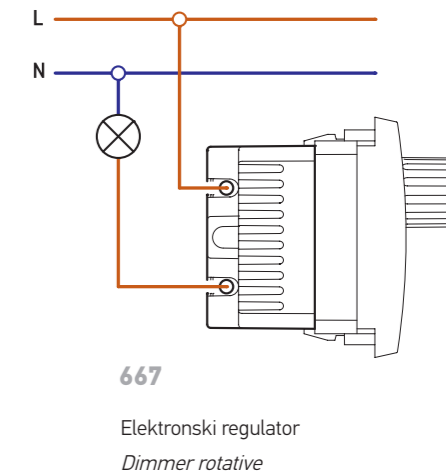

Elektronski regulator
Dimmer rotative

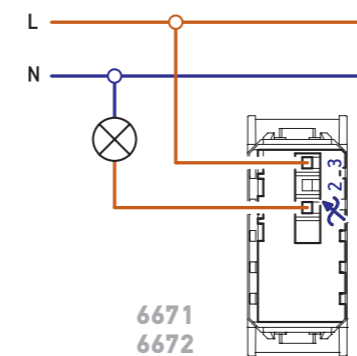

Elektronski regulator sa naizmjeničnom sklopkom
Dimmer with alternative switch

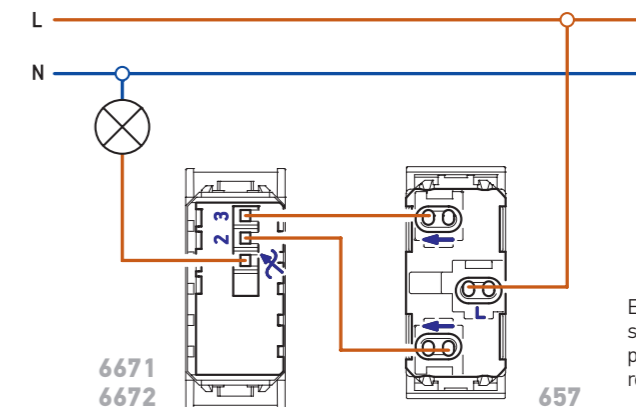

Elektronski regulator sa naizmjeničnom sklopkom, povezivanje u naizmjeničnom režimu rada
Dimmer with alternative switch, wired in alternating mode

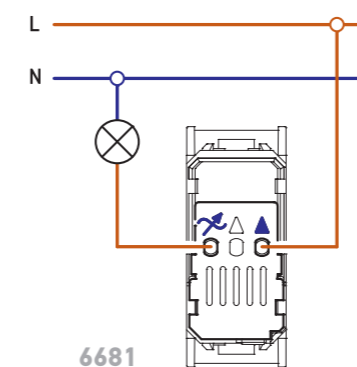

Regulator 40-300VA i regulator 800W sa rotacionom sklopkom povezuju se kao jednopolne sklopke.
Dimmer 40-300VA and dimmer 800W with rotary switch are wired as a single-pole switch.

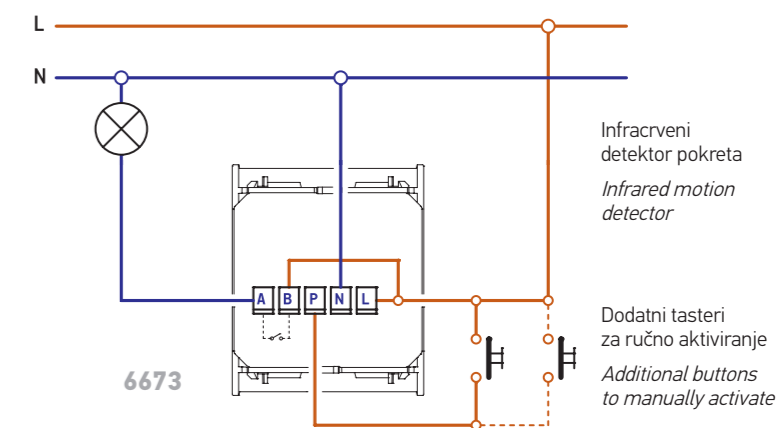

Infracrveni detektor pokreta
Infrared motion detector

Dodatni tasteri za ručno aktiviranje
Additional buttons to manually activate

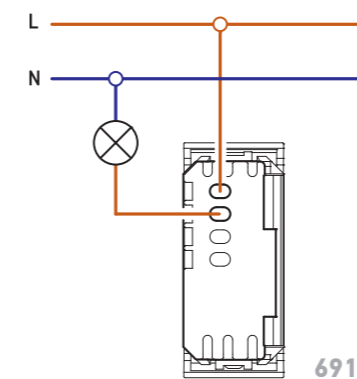

Elektronski regulator priključuje se umesto jednopolne sklopke.
Dimmer is connected instead one pole switch.

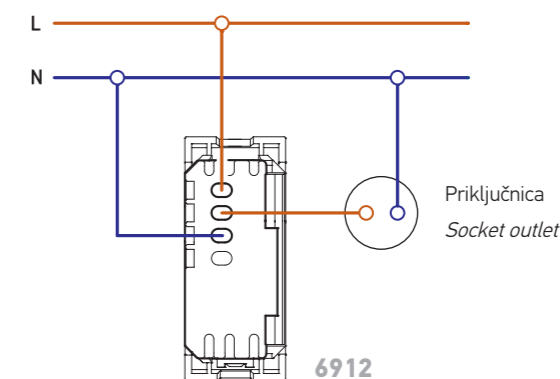

Modul za kontrolu priključnice spaja se ispred priključnice sa priključkom za nulti provodnik. Moguće je vršiti uključivanje, isključivanje, kao i kontrolu snage potrošača.
Socket outlet control module is connected into socket circuit with neutral wire connection. Switching and load power control.

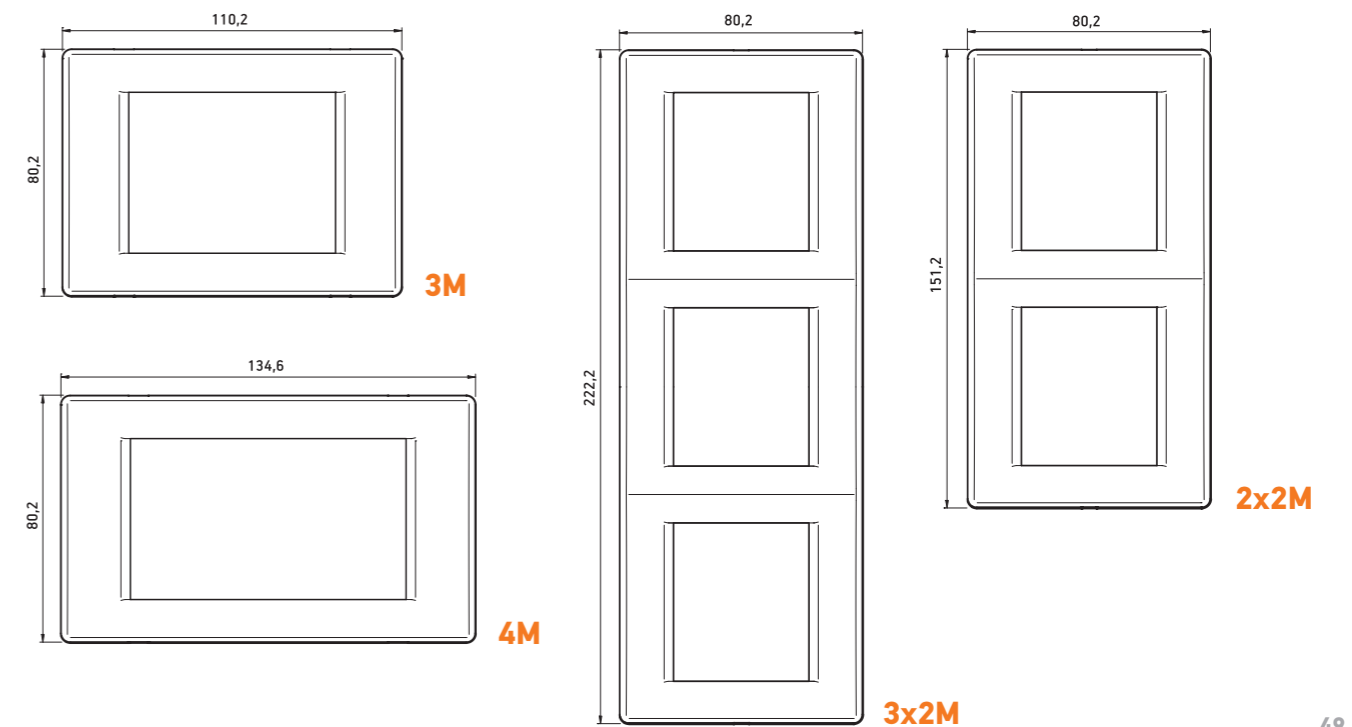
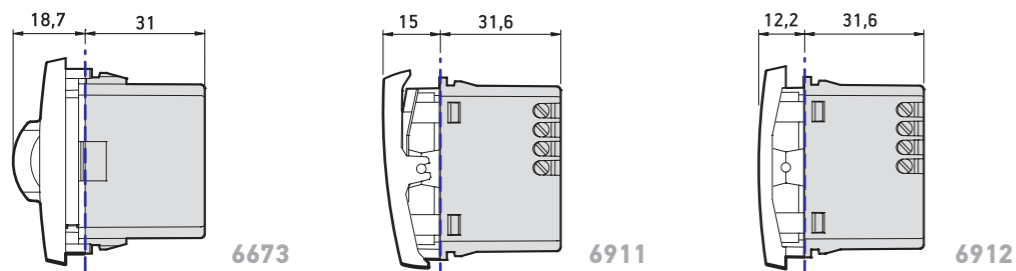
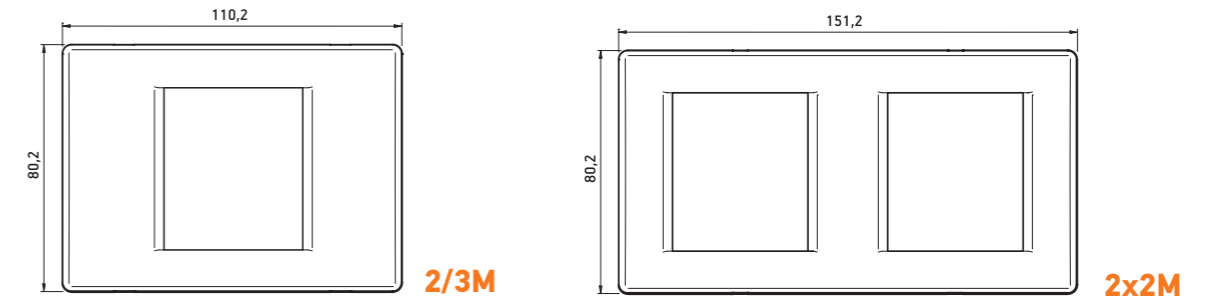
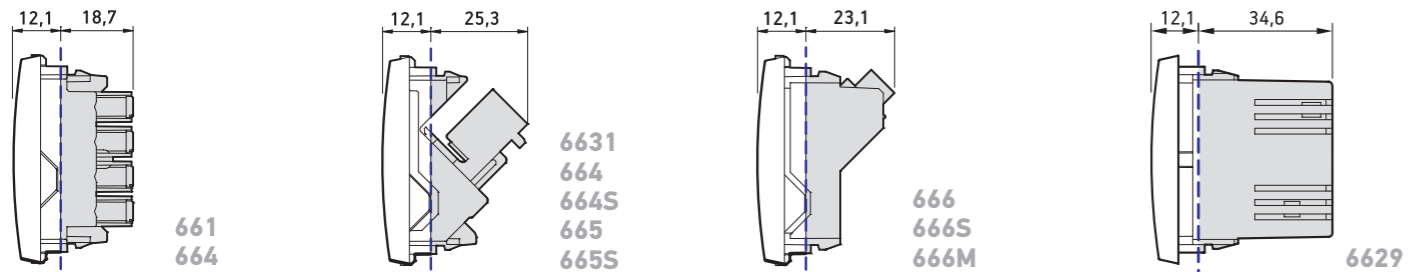
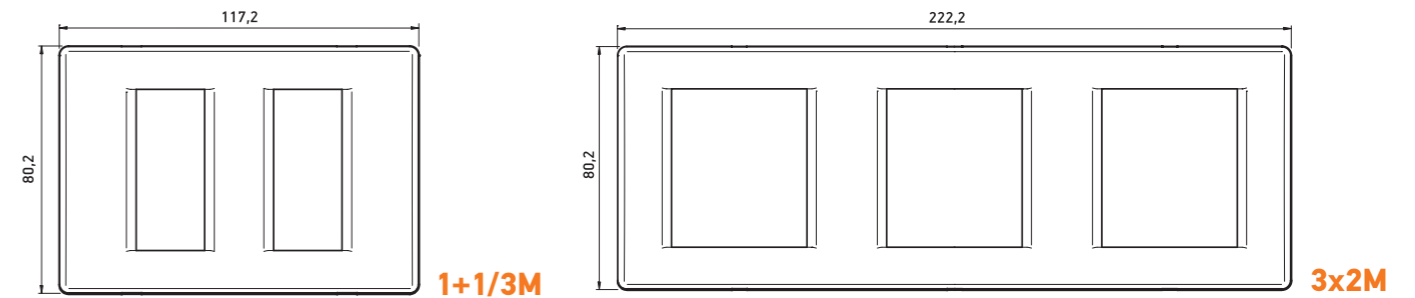
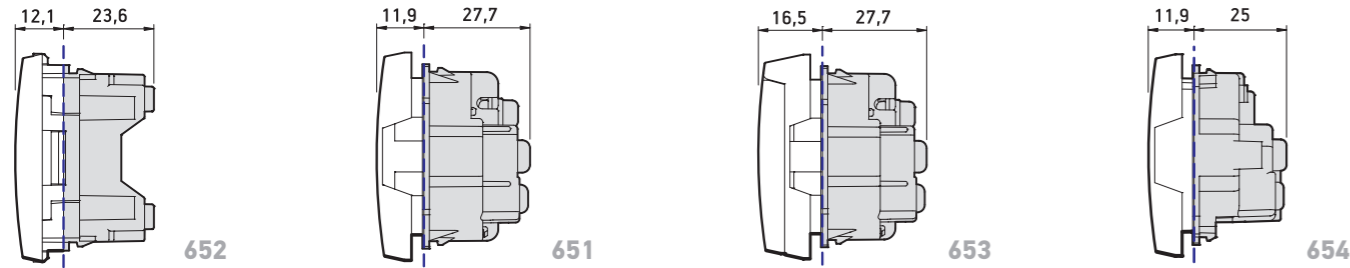
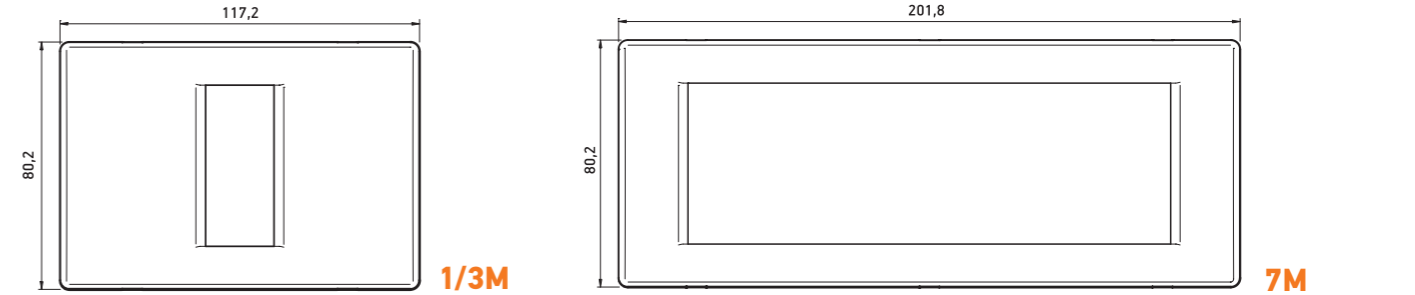
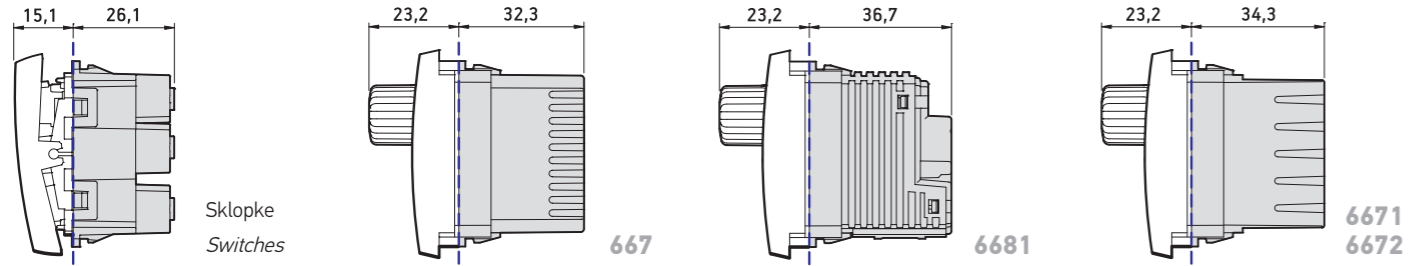
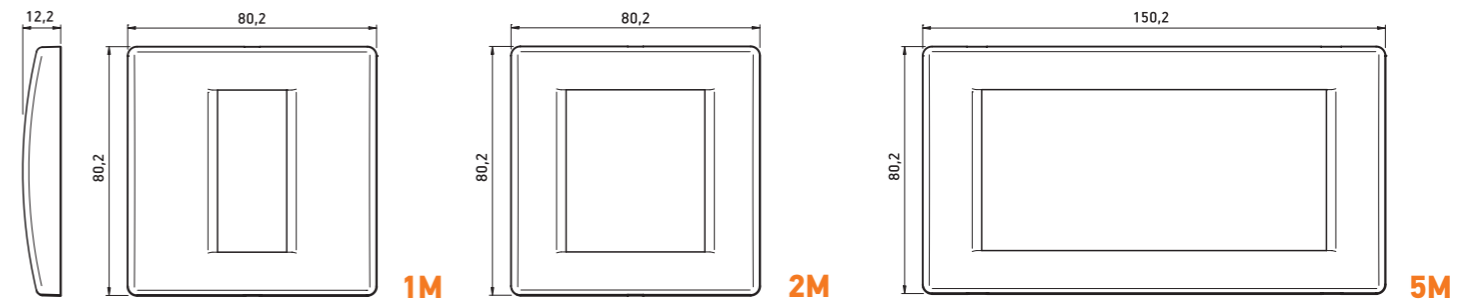
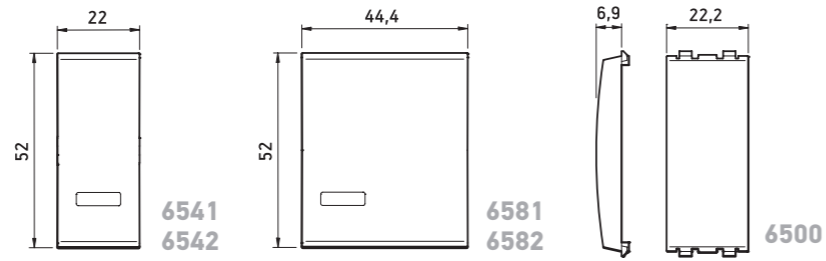

8	SKLOPKE BEZ TASTERA SWITCHES WITHOUT BUTTONS
9	SKLOPKE 10A SWITCHES 10A
11	SKLOPKE 16A SWITCHES 16A
12	TASTERI SWITCH BUTTONS
13	ELEKTRONIKA ELECTRONICS
14	SKLOPKE ZA KUPATILO BATHROOM SWITCHES
16	PRIKLJUČNICE SOCKET OUTLETS
19	KOMUNIKACIJE COMMUNICATIONS
22	DEKORATIVNE MASKE DECORATIVE FRAMES
32	PRIRUBNICE MOUNTING FRAMES
34	UGRADNJA INSTALLATION
36	MONTAŽNE KUTIJE INSTALLATION BOXES
38	MONTAŽNI PRIBOR INSTALLATION ACCESSORIES
40	ANTIBAKTERIJSKI PROGRAM ANTIBACTERIAL PROGRAM
44	HOTELSKI PROGRAM HOTEL PROGRAM
46	ŠEME VEZIVANJA TECHNICAL DRAWINGS
48	TEHNIČKI CRTEŽI TECHNICAL DRAWINGS

ALING 

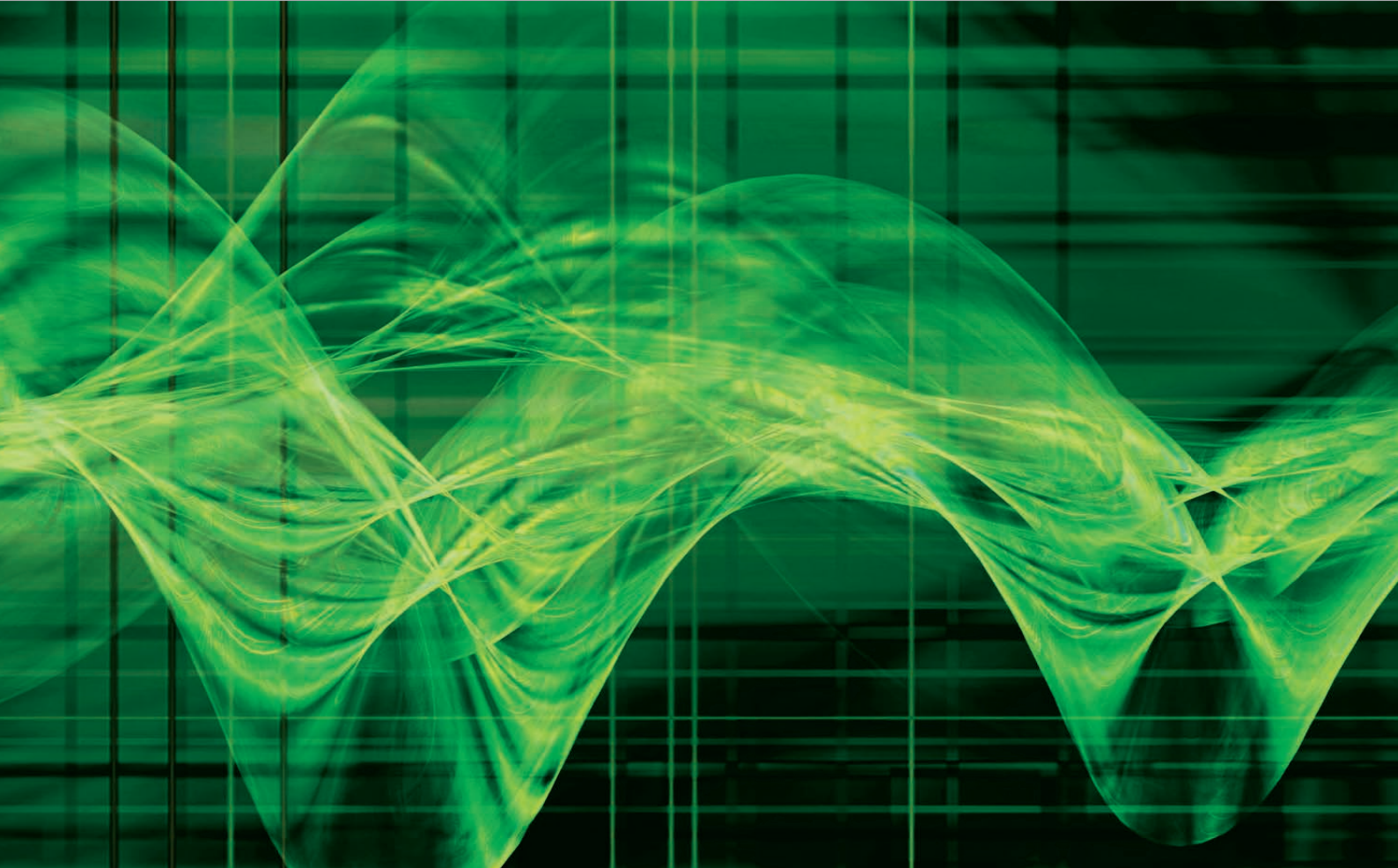

ALING-CONEL

a: Železnička 10, 21432 Gajdobra, Serbia
t: +381 21 762 674, 762 586
f: +381 21 762 779
e: sales@aling-conel.com
www.aling-conel.com